

SECTION **K**

Ground



# Cam-Lok™ Single Pole Connectivity

COMMERCIAL | INDUSTRIAL

**Table of contents**

<b>Cam-Lok™ families</b>	K-2	<b>Posi-Lok™</b>	K-28
<b>Product selector guide</b>	K-3	E0200	K-31
<b>NEMA rating system</b>	K-4	E0200 Panel dimensions	K-33
<b>J-series</b>	K-5	E0400	K-34
E1015	K-7	E0400 Panel dimensions	K-38
E-Z1016	K-10		
E1016	K-12	<b>Posi-Lok™ parts, tools &amp; accessories</b>	K-39
J-series dimensional information	K-19		
<b>Standard series</b>	K-21		
E-Z1018	K-21		
E1018	K-23		
E-Z1018 & E1018 dimensional information	K-26		
<b>Cam-Lok™ parts, tools &amp; accessories</b>	K-27		



# Cam-Lok™ connectors

Cam-Lok plugs and receptacles are the original cam-style single pole connectivity solution for motors, generators, indoor and outdoor lighting distribution panels, stand-by power and other industrial power applications.



## Single pole connectivity

### Cam-Lok™

J-series product applications

- Portable power
- Motors
- Generators



**K-7**

### Posi-Lok™

Product applications

- Power distribution
- Temporary power
- Emergency power



**K-30**

Eaton's Crouse-Hinds Cam-Lok™ single pole connectors are specially designed to provide the ultimate in reliable service, even under the most severe operating conditions.

- Exclusive double cam principle provides a positive, vibration-proof connection
- Safe and easy assembly with normal hand tools or no tools at all
- All insulators are molded from colorfast material providing quick and easy phase identification
- Panel mount receptacles are insulated for direct mounting to steel panels, eliminating the need for costly insulating boards
- All Cam-Lok™ products are 100% insulated, providing a safe connection



## Selecting the correct Cam-Lok™ product series is easy

Just identify the cable size, voltage, amperage and approval requirements

### J series

Series	Ampacity rating (max.)	Voltage rating (max)	Cable sizes	Approvals
E1015	150	600	#8 - #4	UL1691/CSA 22.2
E1016/EZ1016	400	600	#6 - 4/0	UL1691/CSA 22.2
E1017	690	600	250-800 MCM	UL1691/CSA 22.2
E1018/EZ1018	400	600	#2 - 4/0	UL1691/CSA 22.2

### J series NEMA ratings

	NEMA Type 1	NEMA Type 2	NEMA Type 3	NEMA Type 3R	NEMA Type 4
E1015 non-vulcanized plugs	•	•	•	•	
E1015 vulcanized plugs	•	•	•	•	•
E1015 receptacles	•	•	•	•	
E-Z1016 non-vulcanized plugs	•	•	•	•	
E1016 non-vulcanized plugs	•	•	•	•	
E1016 vulcanized plugs	•	•	•	•	•
E1016 receptacles & terminals	•	•	•	•	
Plastic snapback covers	•	•	•	•	
Metal snapback covers	•				
E1016 accessories	•	•	•	•	
E1017 non-vulcanized plugs	•	•	•	•	
E1017 vulcanized plugs	•	•	•	•	•
E1017 receptacles & terminals	•	•	•	•	
E-Z1018 non-vulcanized plugs	•	•	•	•	
E1018 receptacles and terminals	•	•	•	•	

### Posi-Lok™

Series	Ampacity rating (max.)	Voltage rating (max)	Cable sizes	Approvals
E0200	200	600	#2 - 2/0	UL/CSA
E0400	400	600	#2 - 4/0	UL/CSA

### Posi-Lok™ NEMA ratings

	NEMA Type 1	NEMA Type 2	NEMA Type 3	NEMA Type 3R	NEMA Type 4
Posi-Lok™	•	•	•		

See full product listing at [Eaton.com](http://Eaton.com)



## NEMA rating (National Electrical Manufacturers Association)

The NEMA rating indicates the level of protection the device has against water and dirt intrusion

### NEMA enclosure ratings

Protection from	Device locations		
	Indoors	Indoors or outdoors	Outdoors with external mechanisms
Limited amounts of falling dirt	NEMA type 1		
Limited amounts of falling dirt and dripping water	NEMA type 2		
Rain, sleet, falling dirt, windblown dust, damage from ice formation		NEMA type 3	
Rain, sleet, falling dirt, damage from ice formation		NEMA type 3R	
Rain, sleet, windblown dust, ice laden operation possible			NEMA type 3S
Windblown dust and rain, splashing water, hose-directed water, damage from ice formation		NEMA type 4	
Corrosion, windblown dust and rain, splashing water, hose-directed water, damage from ice formation		NEMA type 4X	
Falling dirt and settling airborne dust, lint, fibers and dripping non-corrosive liquids	NEMA type 5		
Hose-directed water, entry of water during occasional short-term limited depth submersion, damage from ice formation		NEMA type 6	
Hose-directed water, entry of water during long-term limited depth submersion, damage from ice formation		NEMA type 6P	
Class I, Division 1, groups A,B,C or D hazardous locations (as defined by NEC®, NFPA 70)	NEMA type 7 (commonly referred to as explosion-proof)		
Class I, Division 1, groups A,B,C or D hazardous locations (as defined by NEC®, NFPA 70)	NEMA type 8 (commonly referred to as oil-immersed)		
Class II, Division 1, groups E, F and G hazardous locations (as defined by NEC®, NFPA 70)	NEMA type 9 (commonly referred to as dust-ignition-proof)		
Meets applicable requirements of the Mine Safety & Health Administration, 30 CFR, part 18		NEMA type 10	
Circulating dust, falling dirt, dripping non-corrosive liquids	NEMA type 12 NEMA type 12K		
Dust, spraying of water, oil and non-corrosive coolant	NEMA type 13		

Compliances, specifications and availability are subject to change without notice.

# Cam-Lock™ J-series applications, features & benefits

Designed for reliable, portable, quick and safe single pole connections

Cam-Lok™ J-series connectors are specifically designed to meet the needs of demanding portable applications. J-series plugs and receptacles are the proven industry standard single pole connectors for reliability and service with added safety

## Applications

- J-series plugs and receptacles are specifically designed for industrial power distribution applications requiring quick, tool-free connections
- Ideal for portable power, power distribution, motors, generators and entertainment applications; J-series replaces traditional hardwiring while cutting downtime and maintenance
- J-series connectors are insulated, shatter/crack resistant and water tight plus heat, weather, ozone, oil and abrasion resistant

## Specifications

### Electrical ratings

- 600 Volts AC/DC
- 690 Amps continuous

### Temperature ratings

- -40° C to 105° C

### Materials

- Accepts cable sizes:  
#8 AWG – 800 MCM
- Insulator material:  
Elastomeric or rubber
- Contact material:  
Brass or copper

### Environmental

- NEMA 3R

### Certifications

- Listed to UL1691
- Listed to CSA C22.2 no.1691-12
- CSA certified to C22.2, no.182.3 LR13963





# Cam-Lok™ J-series applications, features & benefits

## Discover how Cam-Lok™ J-series connectivity outperforms hardwiring

Cam-Lok™ J-series connectors quickly replace traditional hardwiring and offer more safety with integrated watertight insulators and a strain relief system. Plus, a wide range of sizes, colors and accessories are available for complete flexibility

### Features & benefits

Non-metallic retaining screw provides safe, strong and reliable contact retention

Easy assembly with standard tools

Retaining screw snaps into place to prevent loss

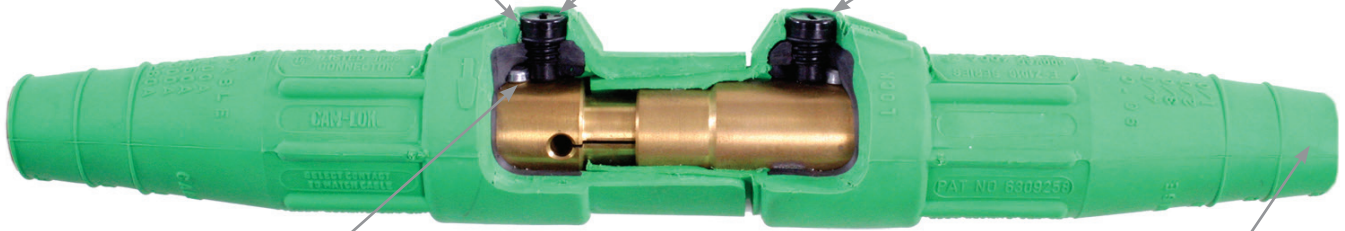

E-Z align drive pin increases torque and longitudinal strength 300%

Accommodates a wide range of cable sizes: #2 – 4/0

Double set screw termination for added strength (crimp also available)



Non-vulcanized E1016 & EZ1016 plugs feature a high-strength, molded-in-place locking ring to capture and secure the insulator to the contact

Fully insulated for direct mounting to steel panels

Threaded stud and double set screw receptacles available (other terminations available)

High impact-resistant thermoplastic protects receptacles from damage



Snapback covers provide NEMA 3R environmental seal



Wide range of colors available

Compliances, specifications and availability are subject to change without notice.

## Cam-Lok™ J-series E1015 plugs

### Product description

Cable size #8 – #4 AWG  
600V AC/DC, up to 150A continuous  
NEMA 3R



E1015-8313



E1015-8333

### J-series E1015, elastomeric, non-vulcanized, single set screw connection

#### Features

- Double cam principle provides a positive, vibration-proof connection
- Self-compensating for wear
- No moving contact surfaces, eliminating arcing or burning
- Superior electromechanical connections
- Locked contacts will withstand a pulling force of 1,000 lbs.
- 1/3 of a turn assures a high pressure contact approaching 600 lbs. per sq. in. providing minimum resistance
- Contacts carefully machined from a high conductivity brass to a smooth sliding fit and easy locking action
- Watertight elastomeric insulators molded from colorfast material, color-coded for easy phase identification
- Recessed contacts protected by insulating jacket that extends beyond contact ends for safety
- Integrated strain relief system features a retaining wire that prevents cable jacket pull-away and bare conductor exposure
- Accepts a wide range of cable sizes

### Set screw non-vulcanized male plugs

Cable size	Color	Complete part no.
#8-#4	BK	E1015-8306
	RD	E1015-8308
	GR	E1015-8310
	WH	E1015-8311
	BU	E1015-8313
	BRN	E1015-8314
	ORG	E1015-8309
	YEL	E1015-8307

### Set screw non-vulcanized female plugs

Cable size	Color	Complete part no.
#8-#4	BK	E1015-8331
	RD	E1015-8333
	GR	E1015-8335
	WH	E1015-8336
	BU	E1015-8338
	BRN	E1015-8339
	ORG	E1015-8334
	YEL	E1015-8332

For E1015 elastomeric, non-vulcanized, single set screw connection drawings, see page K-18

### Color information:

BK (Black), RD (Red), GR (Green), WH (White), BU (Blue), BRN (Brown), ORG (Orange), YEL (Yellow)



**Testing & code compliance:** Listed to UL1691, Listed to CSA C22.2, No. 1691-12, CSA certified to C22.2, No. 182.3 LR 13963

**Material characteristics:** Insulator: TPE, Environmental: NEMA 3R, Temperature rating: Operating ambient: -40° C to 105° C

**Compliances, specifications and availability are subject to change without notice.**



### Cam-Lok™ J-series E1015 receptacles & terminals

#### Product description

Cable size #8 – #4 AWG  
600V AC/DC, up to 150A continuous  
NEMA 3R

#### J-series E1015, elastomeric or rubber

#### Features

- Double cam principle provides a positive, vibration-proof connection
- Self-compensating for wear
- No moving contact surfaces, eliminating arcing or burning
- Superior electromechanical connections
- Locked contacts will withstand a pulling force of 1,000 lbs.
- 1/3 of a turn assures a high pressure contact approaching 600 lbs. per sq. in. providing minimum resistance
- Contacts carefully machined from a high conductivity brass to a smooth sliding fit and easy locking action
- Product body molded from colorfast material, color-coded for easy phase identification
- Receptacles are watertight elastomeric, terminals are rubber
- Recessed contacts protected by insulating jacket that extends beyond contact ends for safety
- Receptacles are safety insulated for direct mounting to steel panels



E1015-1604



E1015-1625

#### Threaded studs

Cable size	Color
#8-#4	BK
	RD
	GR
	WH
	BU
	BRN
	ORG
	YEL

#### Male terminals

Complete part no.
E1015-1600
E1015-1602
E1015-1604
E1015-1605
E1015-1606
E1015-1607
E1015-1603
E1015-1601

#### Female terminals

Complete part no.
E1015-1625
E1015-1627
E1015-1629
E1015-1630
E1015-1631
E1015-1632
E1015-1628
E1015-1626

For E1015 elastomeric or rubber drawings, see page K-18

#### Color information:

BK (Black), RD (Red), GR (Green), WH (White), BU (Blue), BRN (Brown), ORG (Orange), YEL (Yellow)



**Testing & code compliance:** Listed to UL1691, Listed to CSA C22.2, No. 1691-12, CSA certified to C22.2, No. 182.3 LR 13963  
**Material characteristics:** Receptacles: TPE, Terminals: Rubber, Environmental: NEMA 3R, Temperature rating: Operating ambient: -40° C to 105° C

**Compliances, specifications and availability are subject to change without notice.**

## Cam-Lok™ J-series E1015 accessories

### Product description

600V AC/DC, up to 150A continuous  
NEMA 3R

### J-series E1015, rubber

#### Features

- Double cam principle provides a positive, vibration-proof connection
- Self-compensating for wear
- No moving contact surfaces, eliminating arcing or burning
- Superior electromechanical connections
- Locked contacts will withstand a pulling force of 1,000 lbs.
- 1/3 of a turn assures a high pressure contact approaching 600 lbs. per sq. in. providing minimum resistance
- Contacts carefully machined from a high conductivity brass to a smooth sliding fit, even before to locking
- Watertight neoprene insulators molded from color-fast material, color-coded for easy phase identification
- Recessed contacts protected by insulating jacket that extends beyond contact ends for safety



E1015-2314



A100792-1

### Three way "T" connectors

Color	Paralleling "T" complete part no. M-M-F	Tapping "T" complete part no. M-F-F
BK	E1015-2324	E1015-2312
RD	E1015-2326	E1015-2314
GR	E1015-2328	E1015-2316
WH	E1015-2329	E1015-2317
BU	E1015-2348	E1015-2350
BRN	E1015-2342	E1015-2370
ORG	E1015-2327	E1015-2315
YEL	E1015-2325	E1015-2313

### Gender-reversing Adaptors

### Splicers

Double female complete part no.	Double male complete part no.	Male - female complete part no.
E1015-2352	E1015-2362	E1015-2336
E1015-2354	E1015-2364	E1015-2338
E1015-2356	E1015-2366	E1015-2340
E1015-2357	E1015-2367	E1015-2341
E1015-2358	E1015-2368	E1015-2361
E1015-2359	E1015-2369	E1015-2371
E1015-2355	E1015-2365	E1015-2339
E1015-2353	E1015-2363	E1015-2337

### Protective caps

Color	Male	Female
BK	A100793-1	A100792-1
RD	A100793-3	A100792-3
GR	A100793-5	A100792-5
WH	A100793-6	A100792-6
BU	A100793-7	A100792-13
BRN	A100793-8	A100792-7
ORG	A100793-4	A100792-4
YEL	A100793-2	A100792-2

For E1015 rubber drawings, see page K-18

### Color information:

BK (Black), RD (Red), GR (Green), WH (White), BU (Blue), BRN (Brown), ORG (Orange), YEL (Yellow)



**Testing & code compliance:** Listed to UL1691, Listed to CSA C22.2, No. 1691-12, CSA certified to C22.2, No. 182.3 LR 13963

**Material characteristics:** Body: Rubber, Environmental: NEMA 3R, Temperature rating: Operating ambient: -40° C to 105° C

**Compliances, specifications and availability are subject to change without notice.**



### Cam-Lok™ J-series E-Z1016 plugs

#### Product description

Cable size #2 AWG – 2/0  
600V AC/DC, up to 300A continuous  
NEMA 3R



E-Z1016-8354



E-Z1016-8380

J-series E-Z1016, elastomeric, non-vulcanized, double set screw connection

#### Features

- E-Z assembly and disassembly-no tools needed
- Double cam principle provides a positive, vibration-proof connection
- Self-compensating for wear
- No moving contact surfaces, eliminating arcing or burning
- Superior electromechanical connections
- Locked contacts will withstand a pulling force of 1,000 lbs.
- 1/3 of a turn assures a high pressure contact approaching 600 lbs. per sq. in. providing minimum resistance
- Contacts carefully machined from a high conductivity brass to a smooth sliding fit and easy locking action
- Watertight elastomeric insulators molded from color-fast material, color-coded for easy phase identification
- Recessed contacts protected by insulating jacket that extends beyond contact ends for safety
- Integrated strain relief system features a retaining wire that prevents cable jacket pull-away and bare conductor exposure
- Plugs feature a high-strength, molded-in-place locking ring to capture and secure the insulator to the contact
- Accepts a wide range of cable sizes

#### Double set screw non-vulcanized male plugs

Cable size	Color	Complete part no.
#2-2/0	BK	E-Z1016-8350
	RD	E-Z1016-8352
	GR	E-Z1016-8354
	WH	E-Z1016-8355
	BU	E-Z1016-8356
	BRN	E-Z1016-8357
	ORG	E-Z1016-8353
	YEL	E-Z1016-8351

#### Double set screw non-vulcanized female plugs

Cable size	Color	Complete part no.
#2-2/0	BK	E-Z1016-8375
	RD	E-Z1016-8377
	GR	E-Z1016-8379
	WH	E-Z1016-8380
	BU	E-Z1016-8381
	BRN	E-Z1016-8382
	ORG	E-Z1016-8378
	YEL	E-Z1016-8376

For E-Z1016 elastomeric, non-vulcanized, double set screw connection, see page K-18

#### Color information:

BK (Black), RD (Red), GR (Green), WH (White), BU (Blue), BRN (Brown), ORG (Orange), YEL (Yellow)



**Testing & code compliance:** Listed to UL1691, Listed to CSA C22.2, No. 1691-12, CSA certified to C22.2, No. 182.3 LR 13963

**Material characteristics:** Insulator: TPE, Environmental: NEMA 3R, Temperature rating: Operating ambient: -40° C to 105° C

**Compliances, specifications and availability are subject to change without notice.**

## Cam-Lok™ J-series E-Z1016 plugs

### Product description

Cable size 2/0 – 4/0  
600V AC/DC, up to 400A continuous  
NEMA 3R



E-Z1016-8368



E-Z1016-8389

### J-series E-Z1016, elastomeric, non-vulcanized, double set screw connection

#### Features

- E-Z assembly and disassembly-no tools needed
- Double cam principle provides a positive, vibration-proof connection
- Self-compensating for wear
- No moving contact surfaces, eliminating arcing or burning
- Superior electromechanical connections
- Locked contacts will withstand a pulling force of 1,000 lbs.
- 1/3 of a turn assures a high pressure contact approaching 600 lbs. per sq. in. providing minimum resistance
- Contacts carefully machined from a high conductivity brass to a smooth sliding fit and easy locking action
- Watertight elastomeric insulators molded from color-fast material, color-coded for easy phase identification
- Recessed contacts protected by insulating jacket that extends beyond contact ends for safety
- Integrated strain relief system features a retaining wire that prevents cable jacket pull-away and bare conductor exposure
- Plugs feature a high-strength, molded-in-place locking ring to capture and secure the insulator to the contact
- Accepts a wide range of cable sizes

### Double set screw non-vulcanized male plugs

Cable size	Color	Complete part no.
2/0-4/0	BK	E-Z1016-8362
	RD	E-Z1016-8364
	GR	E-Z1016-8366
	WH	E-Z1016-8367
	BU	E-Z1016-8368
	BRN	E-Z1016-8369
	ORG	E-Z1016-8365
	YEL	E-Z1016-8363

### Double set screw non-vulcanized female plugs

Cable size	Color	Complete part no.
2/0-4/0	BK	E-Z1016-8387
	RD	E-Z1016-8389
	GR	E-Z1016-8391
	WH	E-Z1016-8392
	BU	E-Z1016-8393
	BRN	E-Z1016-8394
	ORG	E-Z1016-8390
	YEL	E-Z1016-8388

For E-Z1016 elastomeric, non-vulcanized, double set screw connection, see page K-18

### Color information:

BK (Black), RD (Red), GR (Green), WH (White), BU (Blue), BRN (Brown), ORG (Orange), YEL (Yellow)



**Testing & code compliance:** Listed to UL1691, Listed to CSA C22.2, No. 1691-12, CSA certified to C22.2, No. 182.3 LR 13963

**Material characteristics:** Insulator: TPE, Environmental: NEMA 3R, Temperature rating: Operating ambient: -40° C to 105° C

**Compliances, specifications and availability are subject to change without notice.**

### Cam-Lok™ J-series E1016 receptacles

#### Product description

Cable size #6 AWG – 250 MCM  
600V AC/DC, up to 400A continuous  
NEMA 3R

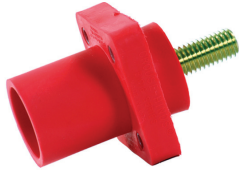

E1016-1602S 1 1/8"

#### J-series E1016, elastomeric, threaded stud

##### Features

- Double cam principle provides a positive, vibration-proof connection
- Self-compensating for wear
- No moving contact surfaces, eliminating arcing or burning
- Superior electromechanical connections
- Locked contacts will withstand a pulling force of 1,000 lbs.
- 1/3 of a turn assures a high pressure contact approaching 600 lbs. per sq. in. providing minimum resistance
- Contacts carefully machined from a high conductivity brass to a smooth sliding fit and easy locking action
- Watertight elastomeric body molded from colorfast material, color-coded for easy phase identification
- Recessed contacts protected by insulating jacket that extends beyond contact ends for safety
- Receptacles are safety insulated for direct mounting to steel panels

#### Insulated receptacles - 1 1/8" threaded stud

Color	Male complete part no.	Female complete part no.
BK	E1016-1600S	E1016-1631S
RD	E1016-1602S	E1016-1633S
GR	E1016-1604S	E1016-1635S
WH	E1016-1605S	E1016-1636S
BU	E1016-1612S	E1016-1643S
BRN	E1016-1619S	E1016-1687S
ORG	E1016-1603S	E1016-1634S
YEL	E1016-1601S	E1016-1632S

Stud size: 1/2"-13, Maximum torque: 40 ft.-lbs.

For E1016 threaded stud receptacle drawings, see page K-20

#### Color information:

BK (Black), RD (Red), GR (Green), WH (White), BU (Blue), BRN (Brown), ORG (Orange), YEL (Yellow)



**Testing & code compliance:** Listed to UL1691, Listed to CSA C22.2, No. 1691-12, CSA certified to C22.2, No. 182.3 LR 13963

**Material characteristics:** Insulator: TPE, Environmental: NEMA 3R, Temperature rating: Operating ambient: -40° C to 105° C

**Compliances, specifications and availability are subject to change without notice.**



## Cam-Lok™ J-series E1016 receptacles

### Product description

Cable size 1/0 – 4/0  
 600V AC/DC, up to 400A continuous  
 480V AC/DC, up to 315A continuous  
 NEMA 3R

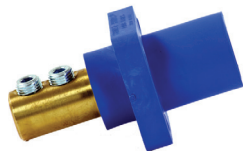

E1016-1706

### J-series E1016, elastomeric - double set screw/inter-lock switch

#### Features

- Double cam principle provides a positive, vibration-proof connection
- Self-compensating for wear
- No moving contact surfaces, eliminating arcing or burning
- Superior electromechanical connections
- Locked contacts will withstand a pulling force of 1,000 lbs.
- 1/3 of a turn assures a high pressure contact approaching 600 lbs. per sq. in. providing minimum resistance
- Contacts carefully machined from a high conductivity brass to a smooth sliding fit and easy locking action
- Watertight elastomeric body molded from colorfast material, color-coded for easy phase identification
- Recessed contacts protected by insulating jacket that extends beyond contact ends for safety
- Receptacles are safety insulated for direct mounting to steel panels

### Insulated receptacles double set screw

Tightening torque		Color	Male complete part no.	Female complete part no.
Cable	Torque (In lbs.)	BK	E1016-1700	E1016-1725
1/0-2/0	120	RD	E1016-1702	E1016-1727
3/0-4/0	220	GR	E1016-1704	E1016-1729
600 Volts		WH	E1016-1705	E1016-1730
400 Amps		BU	E1016-1706	E1016-1731
		BRN	E1016-1707	E1016-1732
		ORG	E1016-1703	E1016-1728
		YEL	E1016-1701	E1016-1726

For E1016 double set screw receptacle drawings, see Page K-20

### Color information:

BK (Black), RD (Red), GR (Green), WH (White), BU (Blue), BRN (Brown), ORG (Orange), YEL (Yellow)



**Testing & code compliance:** Listed to UL1691, Listed to CSA C22.2, No. 1691-12, CSA certified to C22.2, No. 182.3 LR 13963

**Material characteristics:** Body: TPE, Environmental: NEMA 3R, Temperature rating: Operating ambient: -40° C to 105° C

**Compliances, specifications and availability are subject to change without notice.**

### Cam-Lok™ J-series E1016 receptacles

#### Product description

Cable size #2 AWG - 4/0 (threaded stud); 1/0 - 4/0 (double set screw)  
600V AC/DC, up to 400A continuous  
NEMA 3R



E1016-1605S45

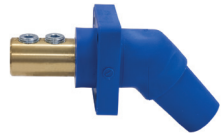

E1016-17341545

#### J-series E1016, elastomeric, non-vulcanized, 45° angled

#### Features

- Double cam principle provides a positive, vibration-proof connection
- Self-compensating for wear
- No moving contact surfaces, eliminating arcing or burning
- Superior electromechanical connections
- Locked contacts will withstand a pulling force of 1,000 lbs.
- 1/3 of a turn assures a high pressure contact approaching 600 lbs. per sq. in. providing minimum resistance
- Contacts carefully machined from a high conductivity brass to a smooth sliding fit and easy locking action
- Watertight elastomeric body molded from colorfast material, color-coded for easy phase identification
- Recessed contacts protected by insulating jacket that extends beyond contact ends for safety
- Receptacles are safety insulated for direct mounting to steel panels

#### Insulated receptacles - 1-1/8" threaded stud

	Color	Male complete part no.	Female complete part no.
1-1/8" threaded stud	BK	E1016-1600S45	E1016-1631S45
	RD	E1016-1602S45	E1016-1633S45
	GR	E1016-1604S45	E1016-1635S45
	WH	E1016-1605S45	E1016-1636S45
	BU	E1016-1612S45	E1016-1643S45
	BRN	E1016-1619S45	E1016-1687S45
	ORG	E1016-1603S45	E1016-1634S45
	YEL	E1016-1601S45	E1016-1632S45

For E1016 threaded stud receptacle drawings, see page K-20

#### Insulated receptacles - double set screw

	Color	Male complete part no.	Female complete part no.
1-1/8" threaded stud	BK	E1016-1700S45	E1016-1725S45
	RD	E1016-1702S45	E1016-1727S45
	GR	E1016-1704S45	E1016-1729S45
	WH	E1016-1705S45	E1016-1730S45
	BU	E1016-1706S45	E1016-1731S45
	BRN	E1016-1707S45	E1016-1732S45
	ORG	E1016-1703S45	E1016-1728S45
	YEL	E1016-1701S45	E1016-1726S45

For E1016 double set screw receptacle drawings, see page K-20

#### Color information:

BK (Black), RD (Red), GR (Green), WH (White), BU (Blue), BRN (Brown), ORG (Orange), YEL (Yellow), GY (Gray)



**Testing & code compliance:** Listed to UL1691, Listed to CSA C22.2, No. 1691-12, CSA certified to C22.2, No. 182.3 LR 13963

**Material characteristics:** Body: TPE, Environmental: NEMA 3R, Temperature rating: Operating ambient: -40° C to 105° C

**Compliances, specifications and availability are subject to change without notice.**

## Cam-Lok™ Receptacles covers

### Product description

NEMA 3R

### J-series E1015/E1016, NEMA 3R receptacle covers

#### Features

- Molded from colorfast material color-coded for easy phase identification
- Mounts directly to new or existing receptacles
- Provides NEMA 3R protection
- High impact resistant thermoplastic covers and bodies
- Stainless steel hardware
- Complete color offering



### NEMA 3R receptacle covers

Color	E1015-series	E1016-series
BK	E1015SC-32	E1016SC-32
RD	E1015SC-36	E1016SC-36
GR	E1015SC-35	E1016SC-35
WH	E1015SC-38	E1016SC-38
BU	E1015SC-34	E1016SC-34
YEL	E1015SC-37	E1016SC-37
ORG	E1015SC-39	E1016SC-39
BRN	E1015SC-31	E1016SC-31
GY	E1015SC-33	E1016SC-33

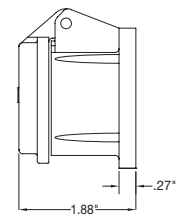
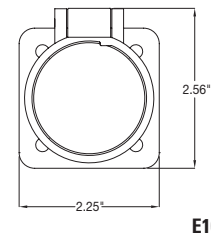
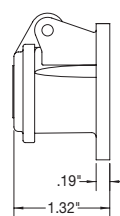
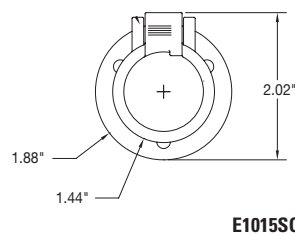

Snap back enclosure assembly

### Color information:

BK (Black), RD (Red), GR (Green), WH (White), BU (Blue), YEL (Yellow), ORG (Orange), BRN (Brown), GY (Gray)



**Testing & code compliance:** Listed to UL1691 **Material characteristics:** Body: Thermoplastic, Environmental: NEMA 3R, Temperature rating: Operating ambient: -40° C to 105° C

**Compliances, specifications and availability are subject to change without notice.**



### Cam-Lok™ J-series E1016 accessories

#### Product description

600V AC/DC, up to 400A continuous  
NEMA 3R

#### J-series E1016 elastomeric

##### Features

- Double cam principle provides a positive, vibration-proof connection
- Self-compensating for wear
- No moving contact surfaces, eliminating arcing or burning
- Superior electromechanical connections
- Locked contacts will withstand a pulling force of 1,000 lbs.
- 1/3 of a turn assures a high pressure contact approaching 600 lbs. per sq. in. providing minimum resistance
- Contacts carefully machined from a high conductivity brass to a smooth sliding fit and easy locking action
- Watertight elastomeric body molded from colorfast material, color-coded for easy phase identification
- Recessed contacts protected by insulating jacket that extends beyond contact ends for safety



E1016-2324



A100601-17

#### Three-way lay-down "T" connectors

Color	Paralleling "T" M-M-F part no.	Tapping "T" M-F-F part no.
BK	E1016-2324	E1016-2312
RD	E1016-2326	E1016-2314
GR	E1016-2328	E1016-2316
WH	E1016-2329	E1016-2317
BU	E1016-2348	E1016-2350
BRN	E1016-2371	E1016-2395
ORG	E1016-2327	E1016-2315
YEL	E1016-2325	E1016-2313

#### Protective caps with lanyards (Not UL Listed)

Color	Male cap part no.	Female cap part no.
BK	A100601-17	A100602-17
RD	A100601-19	A100602-19
GR	A100601-21	A100602-21
WH	A100601-22	A100602-22
BU	A100601-24	A100602-24
BRN	A100601-23	A100602-23
ORG	A100601-20	A100602-20
YEL	A100601-18	A100602-18
Aluminum	100444	Spacer

For E1016 "T" connector drawings, see page K-19

#### Color information:

BK (Black), RD (Red), GR (Green), WH (White), BU (Blue), BRN (Brown), ORG (Orange), YEL (Yellow)



**Testing & code compliance:** Listed to UL1691, Listed to CSA C22.2, No. 1691-12, CSA certified to C22.2, No. 182.3 LR 13963

**Material characteristics:** Body: TPE, Environmental: NEMA 3R, Temperature rating: Operating ambient: -40° C to 105° C

**Compliances, specifications and availability are subject to change without notice.**

## Cam-Lok™ J-series E1016 accessories

### Product description

600V AC/DC, up to 400A continuous  
NEMA 3R

### J-series E1016 elastomeric

#### Features

- Double cam principle provides a positive, vibration-proof connection
- Self-compensating for wear
- No moving contact surfaces, eliminating arcing or burning
- Superior electromechanical connections.
- Locked contacts will withstand a pulling force of 1,000 lbs.
- 1/3 of a turn assures a high pressure contact approaching 600 lbs. per sq. in. providing minimum resistance
- Contacts carefully machined from a high conductivity brass to a smooth sliding fit and easy locking action
- Watertight elastomeric body molded from colorfast material, color-coded for easy phase identification
- Recessed contacts protected by insulating jacket that extends beyond contact ends for safety



E1016-9502



E1016-9510

### Three-fer tapping tees

Color	45° M-F-F-F	45° M-F-F-F
	Part no.	Part no.
BK	E1016-9510	E1016-9580
RD	E1016-9512	E1016-9600
GR	E1016-9514	E1016-9620
WH	E1016-9515	E1016-9630
BU	E1016-9516	E1016-9640
BRN	E1016-9517	E1016-9650
ORG	E1016-9513	E1016-9610
YEL	E1016-9511	E1016-9590

### Adaptors

Color	Double female adapter part no.	Double male adapter part no.
BK	E1016-2352	E1016-2382
RD	E1016-2354	E1016-2384
GR	E1016-2356	E1016-2386
WH	E1016-2357	E1016-2387
BU	E1016-2358	E1016-2388
BRN	E1016-2397	E1016-2389
ORG	E1016-2355	E1016-2385
YEL	E1016-2353	E1016-2383

For E1016 elastomeric drawings, see page K-19

### Color information:

BK (Black), RD (Red), GR (Green), WH (White), BU (Blue), BRN (Brown), ORG (Orange), YEL (Yellow)



**Testing & code compliance:** Listed to UL1691, Listed to CSA C22.2, No. 1691-12, CSA certified to C22.2, No. 182.3 LR 13963

**Material characteristics:** Body: TPE, Environmental: NEMA 3R, Temperature rating: Operating ambient: -40° C to 105° C

**Compliances, specifications and availability are subject to change without notice.**

**J-series E1015, elastomeric, non-vulcanized, single set screw connection**

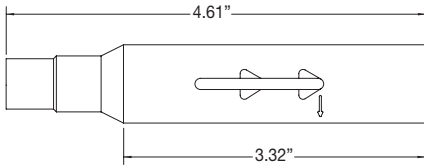

Male non-vulcanized plug

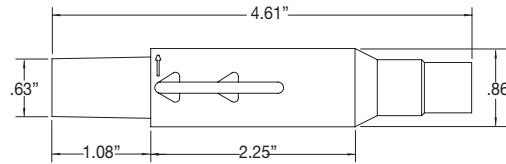

Female non-vulcanized plug

**J-series E1015, elastomeric or rubber**

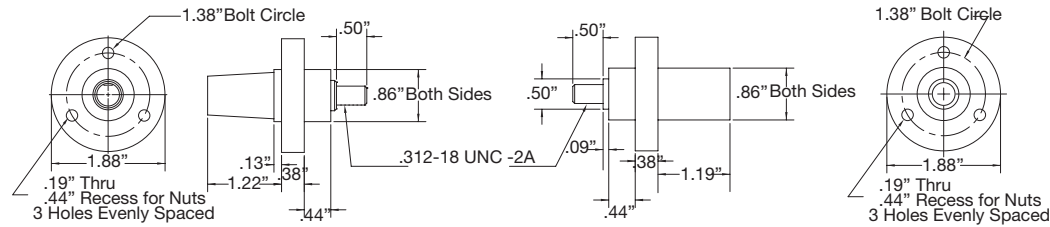

Male & female receptacles

**J-series E1015, rubber**

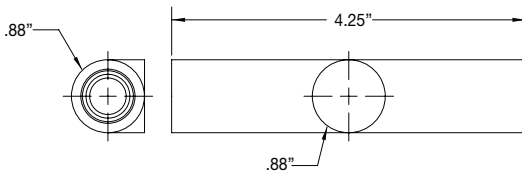

Tapping tee

**J-series E-Z1016, elastomeric, non-vulcanized, double set screw connection & crimp connection**

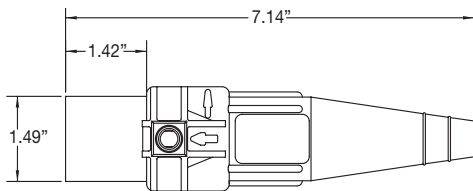

Male connector

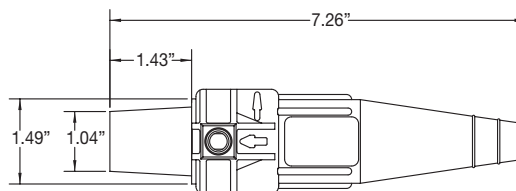

Female connector

Compliances, specifications and availability are subject to change without notice.



# J-series dimensional drawings

## J-series E1016, elastomeric

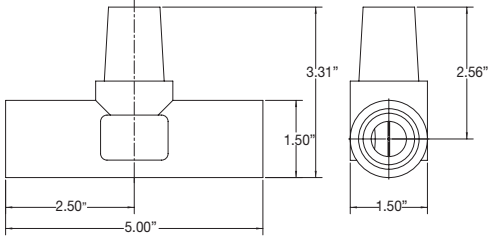

Three-way lay-down "T" connectors

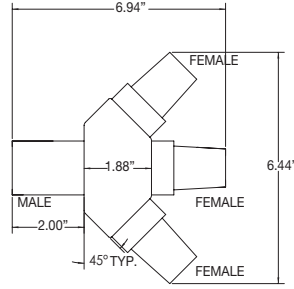

Three-fer tapping tee 45° M-F-F-F

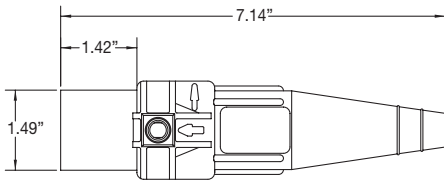

Male Connector

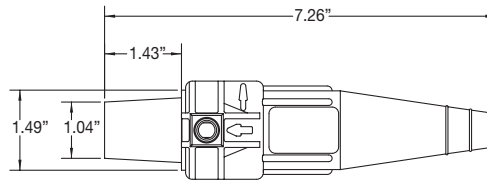

Female Connector

Compliances, specifications and availability are subject to change without notice.

**J-series E1016 receptacles**

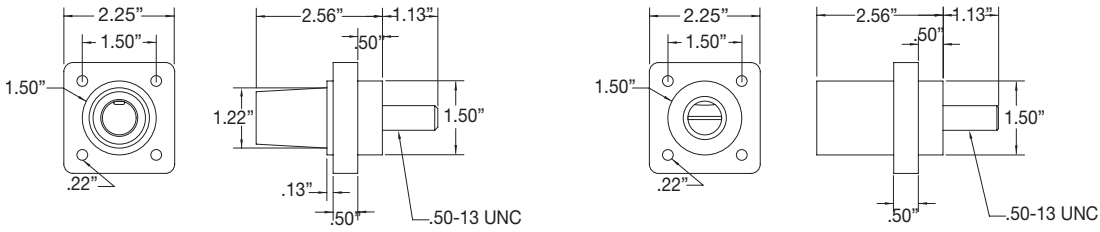

Female & male E1016 threaded stud receptacles, 1 1/8" stud

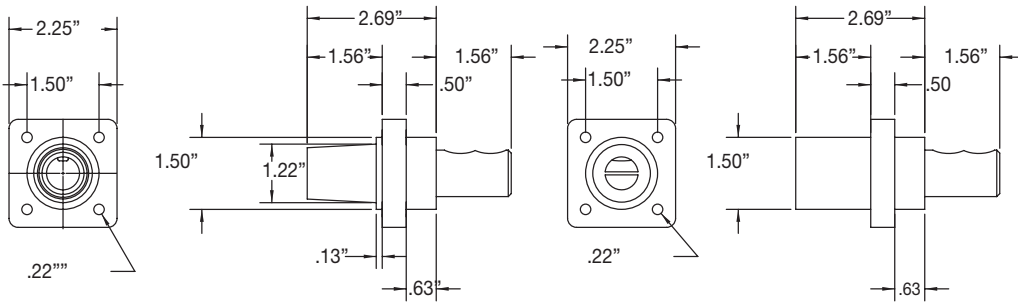

Female & male E1016 double set screw receptacles

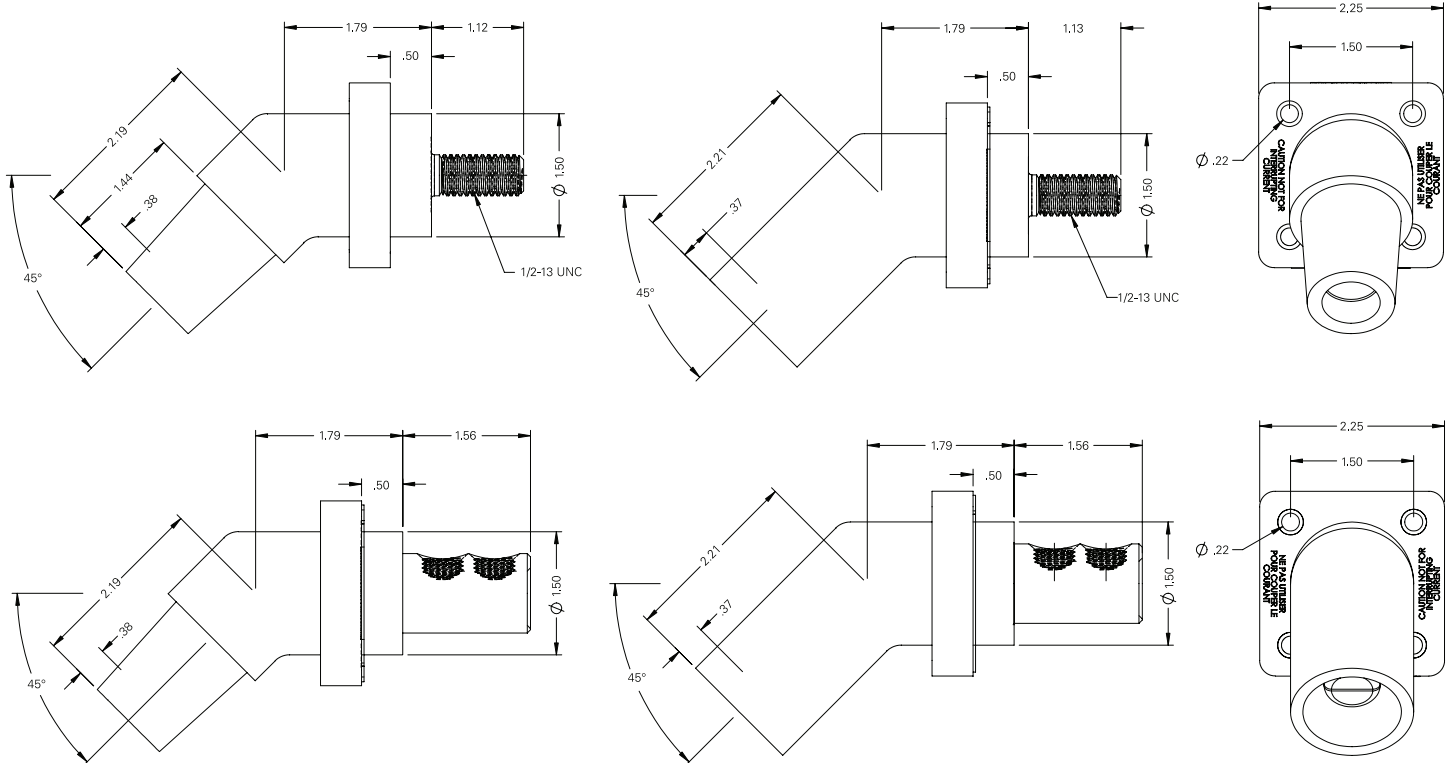

Compliances, specifications and availability are subject to change without notice

## Cam-Lok™ Standard series E-Z1018 plugs

### Product description

Cable size #2 AWG – 2/0  
600V AC/DC, up to 300A continuous  
NEMA 3R



E-Z1018-8354



E-Z1018-8381

Standard series E-Z1018, elastomeric, non-vulcanized, double set screw connection

### Features

- E-Z assembly and disassembly
- Double cam principle provides a positive, vibration-proof connection
- Self-compensating for wear
- No moving contact surfaces, eliminating arcing or burning
- Superior electromechanical connections
- Locked contacts will withstand a pulling force of 1,000 lbs.
- 1/3 of a turn assures a high pressure contact approaching 600 lbs. per sq. in. providing minimum resistance
- Contacts carefully machined from a high conductivity brass to a smooth sliding fit and easy locking action
- Watertight elastomeric insulators molded from colorfast material, color-coded for easy phase identification
- Accepts a wide range of cable sizes

### Double set screw non-vulcanized male plugs

Cable size	Color	Complete part no.
#2-2/0	BK	E-Z1018-8350
	RD	E-Z1018-8352
	GR	E-Z1018-8354
	WH	E-Z1018-8355
	BU	E-Z1018-8356
	BRN	E-Z1018-8357
	ORG	E-Z1018-8353
	YEL	E-Z1018-8351

### Double set screw non-vulcanized female plugs

Cable size	Color	Complete part no.
#2-2/0	BK	E-Z1018-8375
	RD	E-Z1018-8377
	GR	E-Z1018-8379
	WH	E-Z1018-8380
	BU	E-Z1018-8381
	BRN	E-Z1018-8382
	ORG	E-Z1018-8378
	YEL	E-Z1018-8376

For E-Z1018 elastomeric, non-vulcanized double set screw connection drawings, see page K-26

### Color information:

BK (Black), RD (Red), GR (Green), WH (White), BU (Blue), BRN (Brown), ORG (Orange), YEL (Yellow)



**Testing & code compliance:** Listed to UL1691, Listed to CSA C22.2, No. 1691-12, CSA certified to C22.2, No. 182.3 LR 13963

**Material characteristics:** Insulator: TPE, Environmental: NEMA 3R, Temperature rating: Operating ambient: -40° C to 105° C

**Compliances, specifications and availability are subject to change without notice.**



### Cam-Lok™ Standard series E-Z1018 plugs

#### Product description

Cable size 2/0 – 4/0  
600V AC/DC, up to 400A continuous  
NEMA 3R



E-Z1018-8364



E-Z1018-8390

#### Standard series E-Z1018, elastomeric, non-vulcanized, double set screw connection

#### Features

- E-Z assembly and disassembly
- Double cam principle provides a positive, vibration-proof connection
- Self-compensating for wear
- No moving contact surfaces, eliminating arcing or burning
- Superior electromechanical connections
- Locked contacts will withstand a pulling force of 1,000 lbs.
- 1/3 of a turn assures a high pressure contact approaching 600 lbs. per sq. in. providing minimum resistance
- Contacts carefully machined from a high conductivity brass to a smooth sliding fit and easy locking action
- Watertight elastomeric insulators molded from colorfast material, color-coded for easy phase identification
- Accepts a wide range of cable sizes

#### Double set screw non-vulcanized male plugs

Cable size	Color	Complete part no.
2/0-4/0	BK	E-Z1018-8362
	RD	E-Z1018-8364
	GR	E-Z1018-8366
	WH	E-Z1018-8367
	BU	E-Z1018-8368
	BRN	E-Z1018-8369
	ORG	E-Z1018-8365
	YEL	E-Z1018-8363

#### Double set screw non-vulcanized female plugs

Cable size	Color	Complete part no.
2/0-4/0	BK	E-Z1018-8387
	RD	E-Z1018-8389
	GR	E-Z1018-8391
	WH	E-Z1018-8392
	BU	E-Z1018-8393
	BRN	E-Z1018-8394
	ORG	E-Z1018-8390
	YEL	E-Z1018-8388

For E-Z1018 elastomeric, non-vulcanized double set screw connection drawings, see page K-26

#### Color information:

BK (Black), RD (Red), GR (Green), WH (White), BU (Blue), BRN (Brown), ORG (Orange), YEL (Yellow)



**Testing & code compliance:** Listed to UL1691, Listed to CSA C22.2, No. 1691-12, CSA certified to C22.2, No. 182.3 LR 13963

**Material characteristics:** Insulator: TPE, Environmental: NEMA 3R, Temperature rating: Operating ambient: -40° C to 105° C

**Compliances, specifications and availability are subject to change without notice.**

## Cam-Lok™ Standard series E1018 receptacles & accessories

### Product description

Cable size 1/0 – 4/0  
600V AC/DC, up to 400A continuous  
NEMA 3R

### Standard series E1018 elastomeric, double set screw

#### Features

- Double cam principle provides a positive, vibration-proof connection
- Self-compensating for wear
- No moving contact surfaces, eliminating arcing or burning
- Superior electromechanical connections
- Locked contacts will withstand a pulling force of 1,000 lbs.
- Receptacles are safety insulated for direct mounting to steel panels
- 1/3 of a turn assures a high pressure contact approaching 600 lbs. per sq. in. providing minimum resistance
- Contacts carefully machined from a high conductivity brass to a smooth sliding fit and easy locking action
- Watertight elastomeric body molded from colorfast material, color-coded for easy phase identification
- Recessed contacts protected by insulating jacket that extends beyond contact ends for safety



E1018-1700



E1018-1725

### Insulated receptacles - double set screw

Tightening torque		Color	Male complete part no.	Female complete part no.
Cable	Torque (In lbs.)	BK	E1018-1700	E1018-1725
1/0-2/0	120	RD	E1018-1702	E1018-1727
3/0-4/0	220	GR	E1018-1704	E1018-1729
		WH	E1018-1705	E1018-1730
		BU	E1018-1706	E1018-1731
		BRN	E1018-1707	E1018-1732
		ORG	E1018-1703	E1018-1728
		YEL	E1018-1701	E1018-1726

### Three-fer tapping tee 45° M-F-F

Color	Part no.
BK	E1018-9510
RD	E1018-9512
GR	E1018-9514
WH	E1018-9515
BU	E1018-9516
BRN	E1018-9517
ORG	E1018-9513
YEL	E1018-9511

For E1018 elastomeric, double set screw connection drawings, see page K-26

### Color information:

BK (Black), RD (Red), GR (Green), WH (White), BU (Blue), BRN (Brown), ORG (Orange), YEL (Yellow)



**Testing & code compliance:** Listed to UL1691, Listed to CSA C22.2, No. 1691-12, CSA certified to C22.2, No. 182.3 LR 13963  
**Material characteristics:** Insulator: TPE, Environmental: NEMA 3R, Temperature rating: Operating ambient: -40° C to 105° C  
**Compliances, specifications and availability are subject to change without notice.**

### Cam-Lok™ Standard series E1018

#### Product description

Cable size #2 AWG – 4/0  
600V AC/DC, up to 400A continuous  
NEMA 3R



E1018-1600



E1018-1631

#### Standard series E1018 elastomeric, threaded stud

##### Features

- Double cam principle provides a positive, vibration-proof connection
- Self-compensating for wear
- No moving contact surfaces, eliminating arcing or burning
- Superior electromechanical connections
- Locked contacts will withstand a pulling force of 1,000 lbs.
- 1/3 of a turn assures a high pressure contact approaching 600 lbs. per sq. inch providing minimum resistance
- Contacts carefully machined from a high conductivity brass to a smooth sliding fit and easy locking action
- Watertight elastomeric body molded from colorfast material, color-coded for easy phase identification
- Recessed contacts protected by insulating jacket that extends beyond contact ends for safety
- Receptacles are safety insulated for direct mounting to steel panels

#### Insulated receptacles 1 1/8" (28.6mm) threaded stud

	Color	Male complete part no.	Female complete part no.
1 1/8" (28.6mm) threaded stud	BK	E1018-1600S	E1018-1631S
	RD	E1018-1602S	E1018-1633S
Stud size 1/2"-13, maximum torque 40 ft. lbs.	GR	E1018-1604S	E1018-1635S
	WH	E1018-1605S	E1018-1636S
	BU	E1018-1606S	E1018-1637S
	BRN	E1018-1607S	E1018-1638S
	ORG	E1018-1603S	E1018-1634S
	YEL	E1018-1601S	E1018-1632S

For E1018 elastomeric, threaded stud drawings, see page K-26

#### Color information:

BK (Black), RD (Red), GR (Green), WH (White), BU (Blue), BRN (Brown), ORG (Orange), YEL (Yellow)



**Testing & code compliance:** Listed to UL1691, Listed to CSA C22.2, No. 1691-12, CSA certified to C22.2, No. 182.3 LR 13963

**Material characteristics:** Insulator: TPE, Environmental: NEMA 3R, Temperature rating: Operating ambient: -40° C to 105° C

**Compliances, specifications and availability are subject to change without notice.**

## Cam-Lok™ Standard series E1018 accessories

### Product description

Cable size #2 AWG – 4/0  
600V AC/DC, up to 400A continuous  
NEMA 3R



E1018-2324



A100435-1

### Standard series E1018 elastomeric

#### Features

- Double cam principle provides a positive, vibration-proof connection
- Self-compensating for wear
- No moving contact surfaces, eliminating arcing or burning
- Superior electromechanical connections
- Locked contacts will withstand a pulling force of 1,000 lbs.
- 1/3 of a turn assures a high pressure contact approaching 600 lbs. per sq. in. providing minimum resistance
- Contacts carefully machined from a high conductivity brass to a smooth sliding fit and easy locking action.
- Watertight body molded from colorfast material, color-coded for easy phase identification
- Recessed contacts protected by insulating jacket that extends beyond contact ends for safety

### Three way lay-down “T” connectors

Color	Paralleling “T” M-M-F part no.	Tapping “T” M-F-F part no.
BK	E1018-2324	E1018-2312
RD	E1018-2326	E1018-2314
GR	E1018-2328	E1018-2316
WH	E1018-2329	E1018-2317
BU	E1018-2348	E1018-2350
BRN	E1018-2396	E1018-2395
ORG	E1018-2327	E1018-2315
YEL	E1018-2325	E1018-2313

### Protective caps

Color	Male cap part no.	Female cap part no.
BK	A100435-1	A100433-1
RD	A100435-5	A100433-5
GR	A100435-9	A100433-9
WH	A100435-11	A100433-11
BU	A100435-15	A100433-15
BRN	A100435-13	A100433-13
ORG	A100435-7	A100433-7
YEL	A100435-3	A100433-3

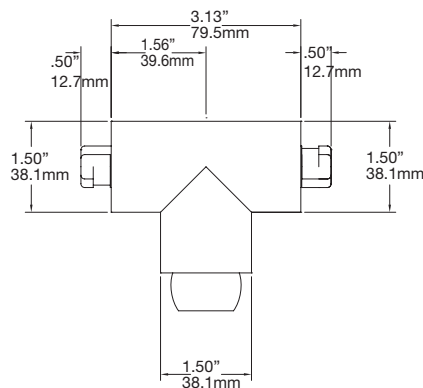

### Color information:

BK (Black), RD (Red), GR (Green), WH (White), BU (Blue), BRN (Brown), ORG (Orange), YEL (Yellow)



**Testing & code compliance:** Listed to UL1691, Listed to CSA C22.2, No. 1691-12, CSA certified to C22.2, No. 182.3 LR 13963

**Material characteristics:** Insulator: TPE, Environmental: NEMA 3R, Temperature rating: Operating ambient: -40° C to 105° C

**Compliances, specifications and availability are subject to change without notice.**

### Standard series E-Z1018, elastomeric, non-vulcanized, double set screw connection

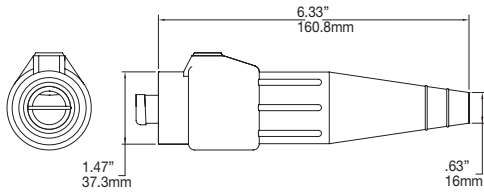

Male connector

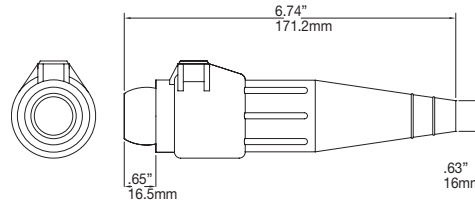

Female connector

### Standard series E1018 elastomeric, double set screw

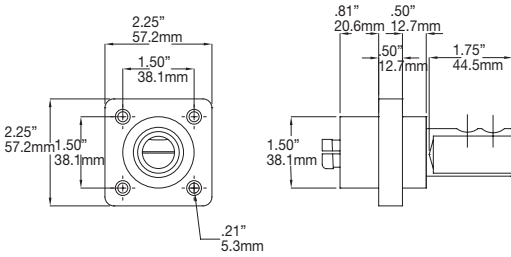

Male receptacle

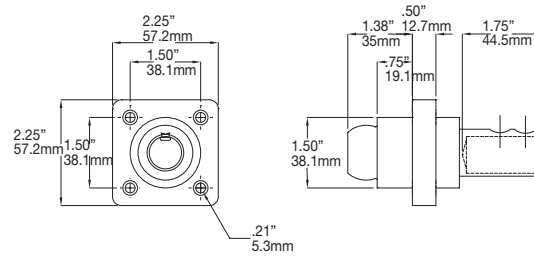

Female receptacle

### Standard series E1018 elastomeric, threaded stud

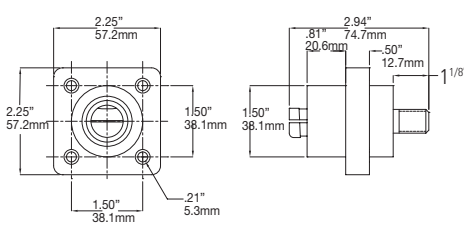

Male receptacle

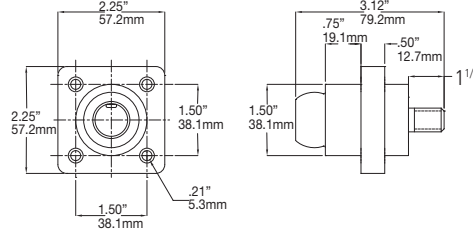

Female receptacle



## Cam-Lok™ parts, tools & accessories

### Product description

Molding press and accessories

### Molding press parts and vulcanizing accessories

Part no.	Description
	All mold kits and presses
A400001*	E1016/E0400 assembly tool
319735-1	Neoprene vulcanizing tape, 1.5" x 30" roll
100566-1	Mold press thermostat
A100632*	Tool for removing contacts from insulators
100826-3	Mold press power on-off switch
A200020-1	COM-A-LONG for pulling male contact in E1015 series
A200020-2	COM-A-LONG for pulling female contact in E1015 series
100827-3	Mold press pilot light - red, complete with wired socket
200704-2	Cartridge heater - 350-750 MCM molds
200704-3	Cartridge heater - #2-4/0 molds
A100072*	Cable cutter - #2-4/0 cable
A200020-3*	COM-A-LONG for pulling male contact in E1012, E1016, E1018 and E0400 series
A200020-4*	COM-A-LONG for pulling female contact in E1012, E1016, E1018 and E0400 series
A200020-5	COM-A-LONG for pulling male contact in E1017 series
A200020-6	COM-A-LONG for pulling female contact in E1017 series
A101208*	2 oz. tube silicon grease for lubricating synthetic rubber insulators

### E1015 & E1016 series crimping nest and presses

Cable size	Crimping nests part no.	Crimping presses
#8	100514-1	A200914-1
#4-6	100514-2	A200914-2
#1-2	100514-3	A200914-3
1/0-2/0	100514-4	A200914-4
3/0	100514-5	A200914-5
4/0	100514-6	A200914-6

Gage block for calibrating crimper: #100891

### Other accessories

Connector series no.	Set screw	Copper shim	Quantity	Pressure pad	Retaining wire
E1010 all	100012-25	A100400-1	25	N/A	100573-1
E1016 single set-screw	100012-18	A100400-3	20	N/A	100573-1
E1018 single set-screw	100012-18	A100400-3	20	N/A	100573-1
E1016 double set-screw	100012-18	A100400-4	20	101214	100573-1

\*See page K-39 for part reference photo

Compliances, specifications and availability are subject to change without notice.

## Quick and safe power distribution connection system

Designed to meet Article 520-53 Section K and Article 530-22 Section A (NEC) Standards, the built-in safety features require the user to connect or disconnect each plug in sequence. Protective receptacle covers cannot be raised until the preceding plug is locked into position

### Applications

- Posi-Lok™ power distribution panels bring a new level of safety to electrical power applications
- Posi-Lok™ systems utilize single conductor cable that can be used to full amperage capability without the need to derate like multi-conductor solutions
- Posi-Lok™ products are ideal for disaster relief, temporary power, standby emergency power and power distribution applications

### Specifications

#### Electrical ratings

- 600 Volts
- 200 Amps continuous (E0200)
- 400 Amps continuous (E0400)

#### Temperature ratings

- -40° C to 105° C

#### Materials

- Cable sizes: #2-4/0
- Insulator: Elastomeric
- Contact: Copper

#### Environmental

- NEMA 3

#### Certifications

- UL Listed: E67181
- CSA certified: LR13963-48

### Features & benefits

Safe, sequential interlock ensures ground mates first and breaks last

Limit switch capabilities

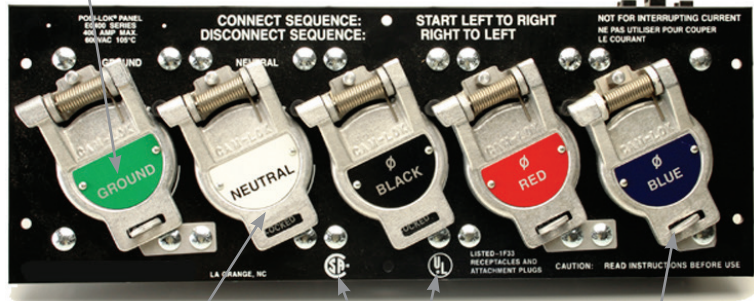

Reliable Posi-Lok™, cross-phase protection system ensures phase integrity

Quick and easy installation - panels can be mounted into a standard 19-inch rack

UL Listed and CSA certified



Lockout-tagout compatible for safety and security

Shatter-resistant insulators and polarizing shells provide long-lasting, durable connectors

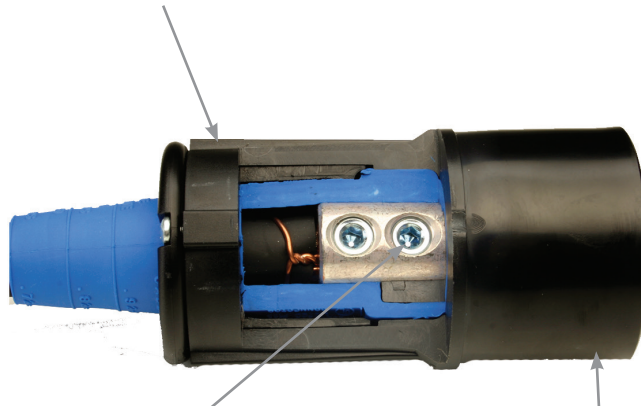

Double set screw termination for added strength and quick installation (crimp also available)

Plugs are uniquely keyed and color-coded to eliminate cross-phasing

Cut-away view of E0400 male plug

Compliances, specifications and availability are subject to change without notice.

# Posi-Lok™ applications, features & benefits



## Quick and efficient standby and emergency power

Posi-Lok™ distribution panels use lightweight, single conductor cables to provide the means for hurried personnel to quickly and safely connect and disconnect power systems without having to use any tools



## Posi-Lok™ connectors

Now there's no need to haul around huge, multi-conductor cables. Posi-Lok™ power distribution systems let you use lighter, single conductor cables rated at higher amperages

Posi-Lok™ plugs feature recessed electrical contacts that are protected by shatter-resistant insulators and impact-resistant molded sleeves

More than 25 years of field testing has proven that the unique elastomeric tapered insulator allows maximum flexing with minimum breakage. There are no metal clamps or grommets to cause cable failure

## Features & benefits

Termination barrel (set screw version shown). Crimp style also available

O-Ring

Contact retaining nut

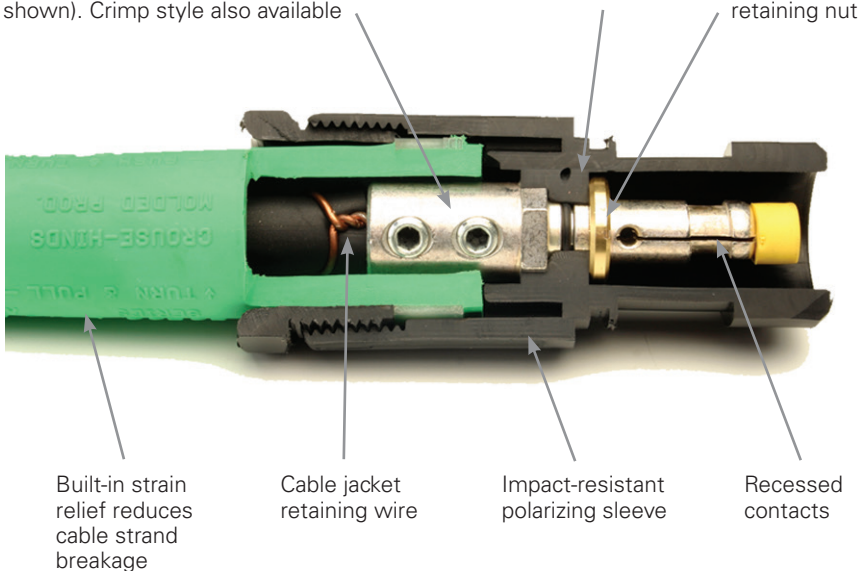

The same plugs that connect to panels also connect to each other so that you can use long runs of cable. Polarity is assured because each plug is uniquely keyed and color-coded for easy, positive connecting

Cut-away view of E0200 male plug

Compliances, specifications and availability are subject to change without notice.

Eaton.com  
Eaton.com/wiringdevices



EATON Wiring Devices Buyers Guide





**Posi-Lok™ plugs and panels**

**Technical information**

- Ampacity is based on cable size or continuous rating, whichever is less
- Panel does not include enclosure or breakers, Posi-Lok™ system must be installed per local and national standards
- Panel receptacles have lock washers, flat washers and jam nuts included
- Plugs and panels have silver plated copper contacts

**Posi-Lok™ E0200 ratings**

Cable size	Amperage rating	Voltage rating
#2 AWG	190 AMPS	600 V AC
#1 AWG	200 AMPS	600 V AC
1/0	200 AMPS	600 V AC
2/0	200 AMPS	600 V AC

**Posi-Lok™ E0400 ratings**

Cable size	Amperage rating	Voltage rating
#2 AWG	190 AMPS	600 V AC
#1 AWG	220 AMPS	600 V AC
1/0	260 AMPS	600 V AC
2/0	300 AMPS	600 V AC
3/0	350 AMPS	600 V AC
4/0	400 AMPS	600 V AC



Compliances, specifications and availability are subject to change without notice.

## Posi-Lok™ plugs and panels E0200 series

### Product description

Cable size #2 AWG-2/0

600V AC/DC, up to 200A continuous



### Posi-Lok™ E0200 series female panels and male plugs

#### Features

- Designed to meet Article 520-53 Section K and Article 530-22 Section A (NEC) standards
- Sequential interlock system requires the user to connect and disconnect each plug in sequence
- Polarized plugs and panels eliminate the possibility of cross-phasing
- Built-in strain relief reduces cable strain
- Proven Cam-Lok™ double cam principle provides a positive, vibration-proof connection
- No moving contact surfaces, eliminating arching or burning of contacts
- Recessed contacts protected by insulating jacket that extends beyond contact ends for safety

#### Female panel part numbers

Receptacles per panel	Female panels	Cover color code
3	E0200-1685	GR, WH, BK
4	E0200-1686-NN	GR, BK, RD, BU
4	E0200-1696	GR, WH, BK, RD
4	E0200-1892-NN	GR, BRN, ORG, YEL
5	E0200-1687	GR, WH, BK, RD, BU
5	E0200-1890	GR, WH, BRN, ORG, YEL
5	E0200-1885	GR, WH, BK, RD, BU

Plugs must be ordered separately. See below.

#### Male plugs

Termination	Position	Male complete part no.
Double set screw	GR	E0200-181
	WH	E0200-182
	BK	E0200-183
	RD	E0200-184
	BU	E0200-185
	BRN	E0200-199
	ORG	E0200-195
	YEL	E0200-192

Male plug assembled length is 8 3/4"

#### Color information:

BK (Black), RD (Red), GR (Green), WH (White), BU (Blue), BRN (Brown), ORG (Orange), YEL (Yellow)

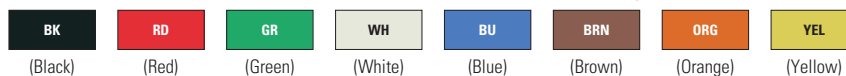

**Testing & code compliance:** Listed to UL498, file no. E67181, CSA certified to C22.2, no. 182.3-M1987, file no. LR13963

**Material characteristics:** Insulator: TPE, Polarizing shell: Thermoplastic, Temperature rating: -40° C to 105° C

**Compliances, specifications and availability are subject to change without notice.**



### Posi-Lok™ plugs and panels E0200 series

#### Product description

Cable size #2 AWG-2/0  
600V AC/DC, up to 200A continuous

#### Posi-Lok™ E0200 series male panels and female plugs

##### Features

- Designed to meet Article 520-53 Section K and Article 530-22 Section A (NEC) standards
- Sequential interlock system requires the user to connect and disconnect each plug in sequence
- Polarized plugs and panels eliminate the possibility of cross-phasing
- Built-in strain relief reduces cable strain
- Proven Cam-Lok™ double cam principle provides a positive, vibration-proof connection
- No moving contact surfaces, eliminating arching or burning of contacts
- Recessed contacts protected by insulating jacket that extends beyond contact ends for safety

#### Male panel part numbers

Receptacles per panel	Male panels	Cover color code
3	E0200-1660	GR, WH, BK
4	E0200-1661-NN	GR, BK, RD, BU
4	E0200-1672	GR, WH, BK, RD
4	E0200-1893-NN	GR, BRN, ORG, YEL
5	E0200-1662	GR, WH, BK, RD, BU
5	E0200-1891	GR, WH, BRN, ORG, YEL
5	E0200-1860	GR, WH, BK, RD, BU

Plugs must be ordered separately. See below.

#### Female plugs

Termination	Position	Female complete part no.
Double set screw	GR	E0200-281
	WH	E0200-282
	BK	E0200-283
	RD	E0200-284
	BU	E0200-285
	BRN	E0200-288
	ORG	E0200-289
	YEL	E0200-286

Female plug assembled length is 8 3/4"



#### Color information:

BK (Black), RD (Red), GR (Green), WH (White), BU (Blue), BRN (Brown), ORG (Orange), YEL (Yellow)

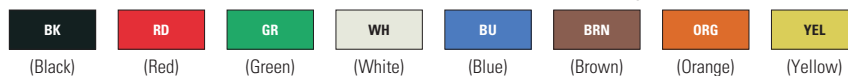

**Testing & Code Compliance:** Listed to UL498, file no. E67181, CSA certified to C22.2, no. 182.3-M1987, file no. LR13963

**Material Characteristics:** Insulator: TPE, Polarizing Shell: Thermoplastic, Temperature rating: -40° C to 105° C

**Compliances, specifications and availability are subject to change without notice.**

# Posi-Lok™ E0200 panel dimensions



## Cut-out and product dimensions

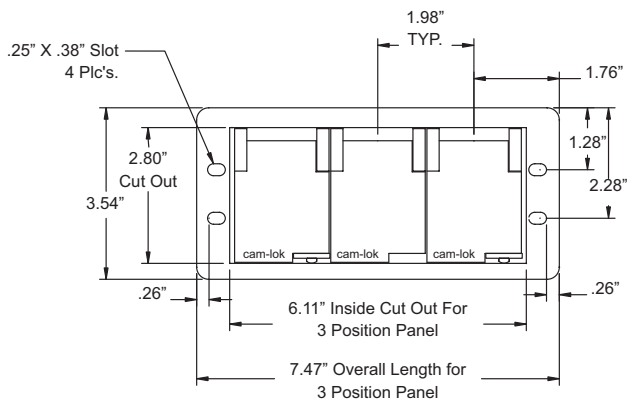
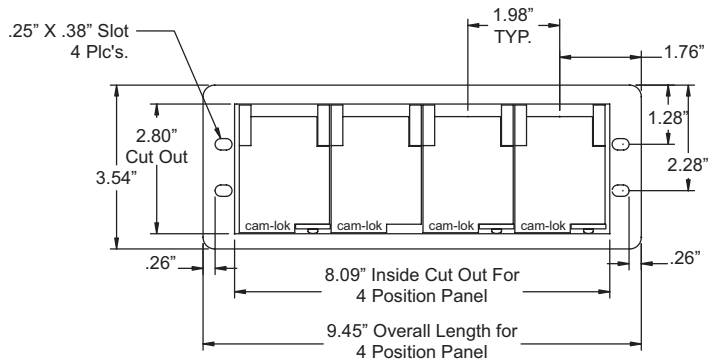
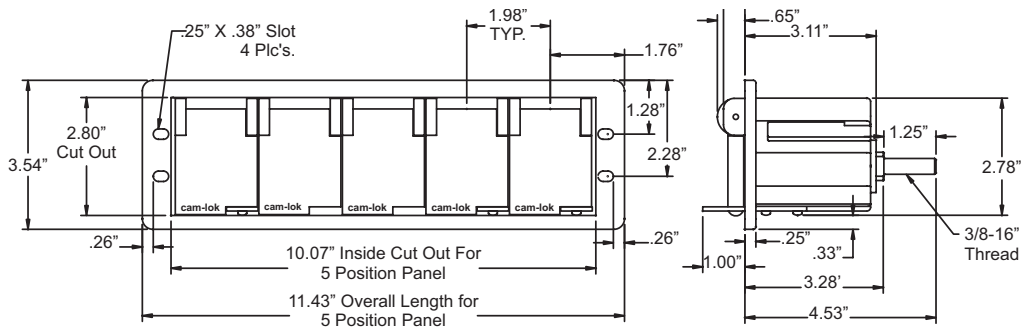
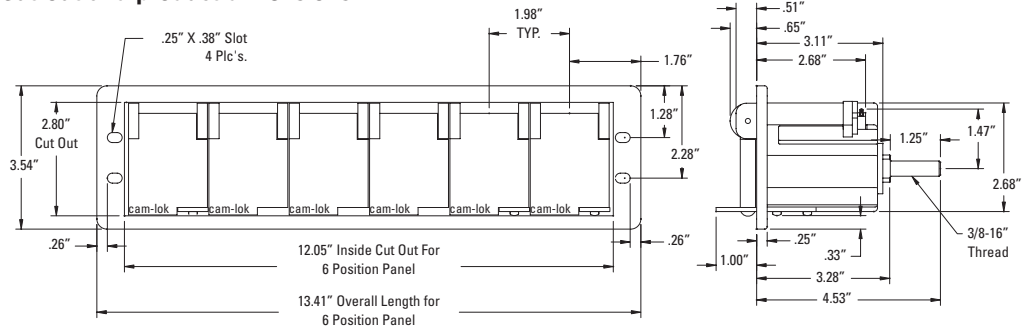

All measurements are in inches.

**Compliances, specifications and availability are subject to change without notice.**

### Posi-Lok™ panels E0400 series

#### Product description

Cable size #2 AWG - 4/0  
600V AC/DC, up to 400A continuous

#### Posi-Lok™ E0400 series female panels

##### Features

- Designed to meet Article 520-53 Section K and Article 530-22 Section A (NEC) standards
- Sequential interlock system requires the user to connect and disconnect each plug in sequence
- Polarized panels eliminate the possibility of cross-phasing
- Proven Cam-Lok™ double cam principle provides a positive, vibration-proof connection
- No moving contact surfaces, eliminating arching or burning of contacts
- Recessed contacts protected by insulating jacket that extends beyond contact ends for safety

#### Female panel part numbers

Receptacles per panel	Female panels	Cover color code	
3**	E0400-1685	GR, WH, BK	GR=Green WH=White
4*	E0400-1686-NN	GR, BK, RD, BU	BK=Black RD=Red
4*	E0400-1696	GR, WH, BK, RD	BU=Blue
4*	E0400-1883-NN	GR, BRN, ORG, YEL	BRN=Brown ORG=Orange YEL=Yellow
5	E0400-1687	GR, WH, BK, RD, BU	NN=Panel without Neutral
5	E0400-1702	GR, WH, BRN, ORG, YEL	
6	E0400-1885	GR, WH, WH, BK, RD, BU	

#### Plugs must be ordered separately.

\*Panels with 4 receptacles will have 2 blank plates to match the same footprint as 5 receptacle panels

\*\*Panels with 3 receptacles will have 2 blank plates to match the same footprint as 5 receptacle panels

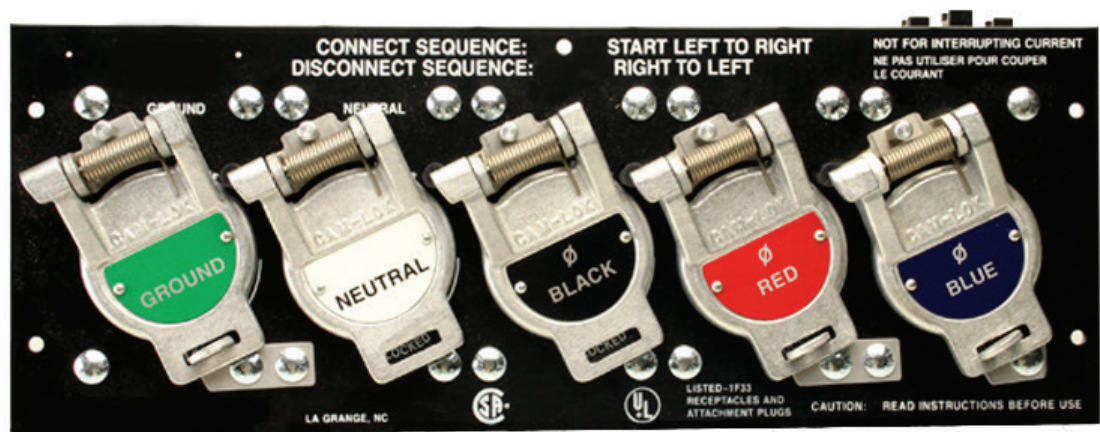

#### Color information:

BK (Black), RD (Red), GR (Green), WH (White), BU (Blue), BRN (Brown), ORG (Orange), YEL (Yellow)

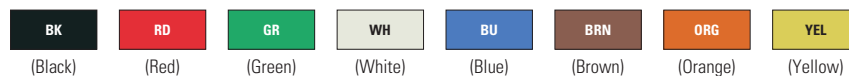

**Testing & code compliance:** Listed to UL498, file no. E67181, CSA certified to C22.2, no. 182.3-M1987, file no. LR13963

**Material characteristics:** Panel: Steel, Temperature rating: -40° C to 105° C

**Compliances, specifications and availability are subject to change without notice.**

## Posi-Lok™ plugs E0400 series

### Product description

Cable size #2 AWG - 4/0  
600V AC/DC, up to 400A continuous

### Posi-Lok™ E0400 series male plugs, crimp & double set screw

#### Features

- Designed to meet Article 520-53 Section K and Article 530-22 Section A (NEC) standards
- Polarized plugs eliminate the possibility of cross-phasing
- Built-in strain relief reduces cable strain
- Proven Cam-Lok™ double cam principle provides a positive, vibration-proof connection
- No moving contact surfaces, eliminating arching or burning of contacts
- Recessed contacts protected by insulating jacket that extends beyond contact ends for safety

#### Male plugs

Termination	Position	Male complete part no.
Double set screw #2-2/0	GR	E0400-151
	WH	E0400-152
	BK	E0400-153
	RD	E0400-154
	BU	E0400-155
	BRN	E0400-156
	ORG	E0400-157
	YEL	E0400-158
Double set screw 3/0-4/0	GR	E0400-181
	WH	E0400-182
	BK	E0400-183
	RD	E0400-184
	BU	E0400-185
	BRN	E0400-199
	ORG	E0400-195
	YEL	E0400-192

Assembled length is 7 1/4"



**Testing & code compliance:** Listed to UL498, file no. E67181, CSA certified to C22.2, no. 182.3-M1987, file no. LR13963  
**Material characteristics:** Insulator: TPE, Polarizing shell: Thermoplastic, Temperature rating: -40° C to 105° C  
**Compliances, specifications and availability are subject to change without notice.**

### Posi-Lok™ plugs & panels E0400 series

#### Product description

Cable size #2 AWG - 4/0  
600V AC/DC, up to 400A continuous

#### Posi-Lok™ E0400 series male panels

##### Features

- Designed to meet Article 520-53 Section K and Article 530-22 Section A (NEC) standards
- Sequential interlock system requires the user to connect and disconnect each plug in sequence
- Polarized panels eliminate the possibility of cross-phasing
- Proven Cam-Lok™ double cam principle provides a positive, vibration-proof connection
- No moving contact surfaces, eliminating arching or burning of contacts
- Recessed contacts protected by insulating jacket that extends beyond contact ends for safety

#### Male panel part numbers

Receptacles per panel	Male panels	Cover color code	
3**	E0400-1660	GR, WH, BK	GR=Green WH=White
4*	E0400-1661-NN	GR, BK, RD, BU	BK=Black
4*	E0400-1672	GR, WH, BK, RD	RD=Red
4*	E0400-1862-NN	GR, BRN, ORG, YEL	BU=Blue BRN=Brown
5	E0400-1662	GR, WH, BK, RD, BU	ORG=Orange
5	E0400-1703	GR, WH, BRN, ORG, YEL	YEL=Yellow
6	E0400-1860	GR, WH, WH, BK, RD, BU	NN=Panel without Neutral

#### Plugs must be ordered separately.

\*Panels with 4 receptacles will have 2 blank plates to match the same footprint as 5 receptacle panels

\*\*Panels with 3 receptacles will have 2 blank plates to match the same footprint as 5 receptacle panels

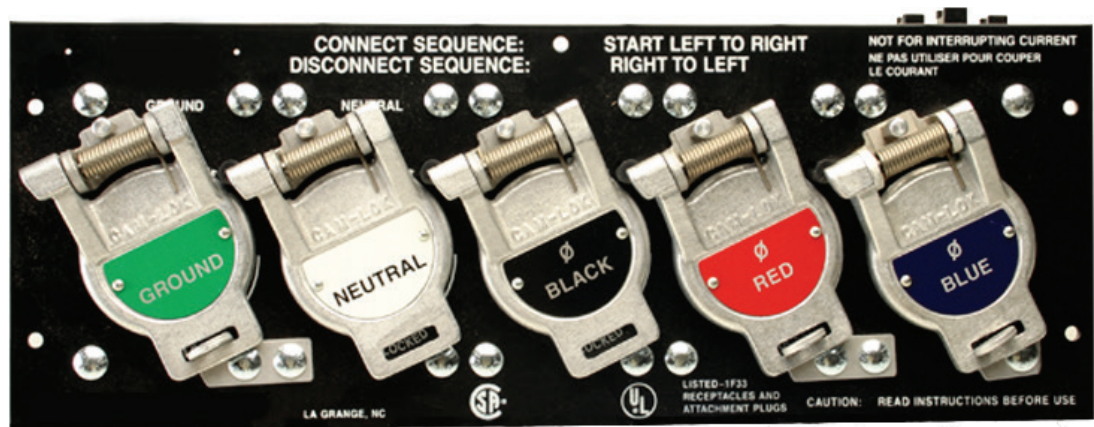

#### Color information:

BK (Black), RD (Red), GR (Green), WH (White), BU (Blue), BRN (Brown), ORG (Orange), YEL (Yellow)

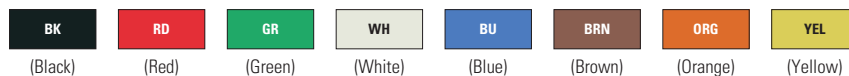

**Testing & code compliance:** Listed to UL498, file no. E67181, CSA certified to C22.2, no. 182.3-M1987, file no. LR13963

**Material characteristics:** Insulator: TPE, Polarizing shell: Thermoplastic, Temperature rating: -40° C to 105° C

**Compliances, specifications and availability are subject to change without notice.**



## Posi-Lok™ plugs & panels E0400 series

### Product description

Cable size #2 AWG - 4/0  
600V AC/DC, up to 200A continuous

### Posi-Lok™ E0400 series female plugs, crimp & double set screw

#### Features

- Designed to meet Article 520-53 Section K and Article 530-22 Section A (NEC) standards
- Polarized plugs eliminate the possibility of cross-phasing
- Proven Cam-Lok™ double cam principle provides a positive, vibration-proof connection
- No moving contact surfaces, eliminating arching or burning of contacts
- Recessed contacts protected by insulating jacket that extends beyond contact ends for safety
- Built-in strain relief reduces cable strain

#### Female plugs

Termination	Position	Female complete part no.
Double set screw #2-2/0	GR	E0400-251
	WH	E0400-252
	BK	E0400-253
	RD	E0400-254
	BU	E0400-255
	BRN	E0400-256
	ORG	E0400-257
	YEL	E0400-258
Double set screw 3/0-4/0	GR	E0400-281
	WH	E0400-282
	BK	E0400-283
	RD	E0400-284
	BU	E0400-285
	BRN	E0400-299
	ORG	E0400-295
	YEL	E0400-292

Female plug assembled length is 7 1/4"



**Testing & code compliance:** Listed to UL498, file no. E67181, CSA certified to C22.2, no. 182.3-M1987, file no. LR13963  
**Material characteristics:** Insulator: TPE, Polarizing shell: Thermoplastic, Temperature rating: -40° C to 105° C  
**Compliances, specifications and availability are subject to change without notice.**

### Cut-out and product dimensions/caps

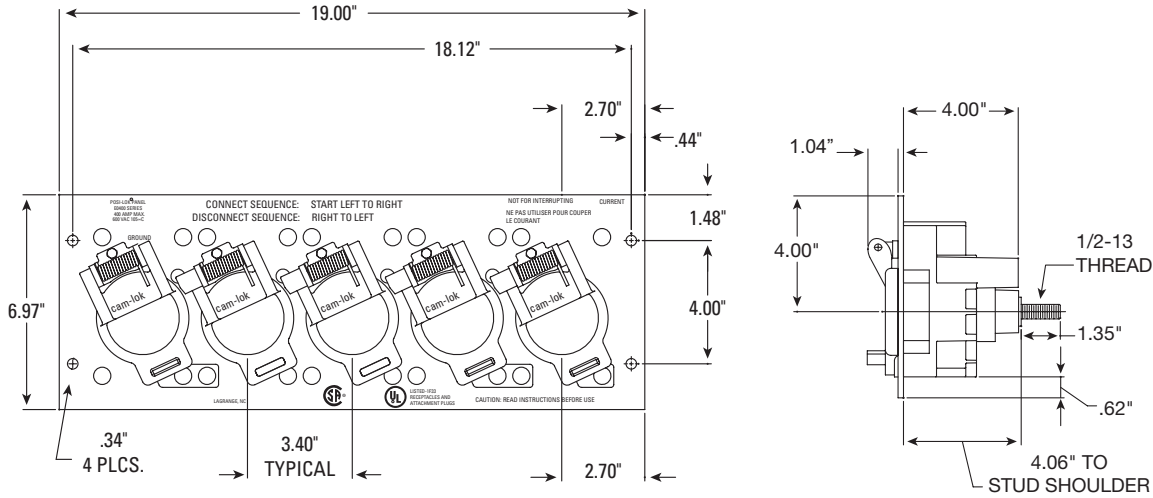

### Panel without limit switch mounting dimensions

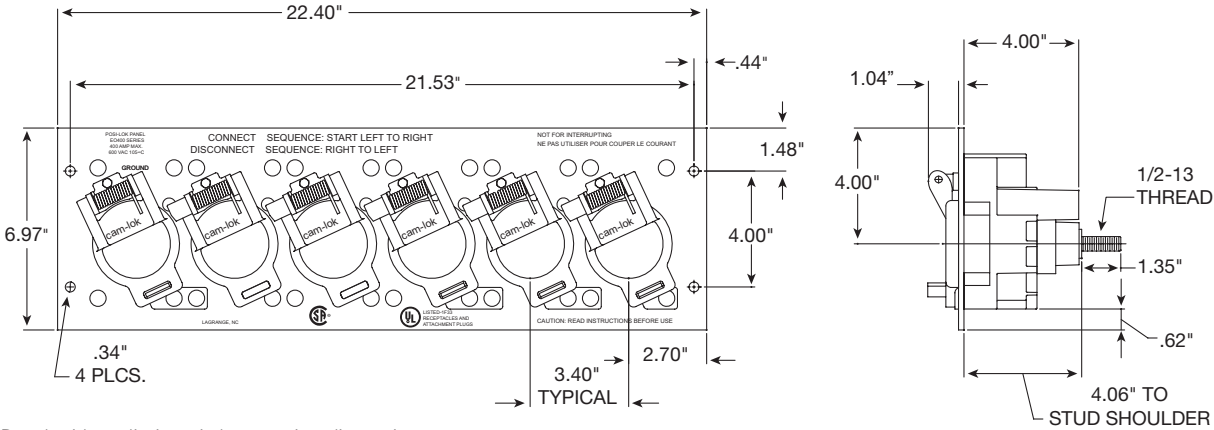

### Panel without limit switch mounting dimensions

### Protective plug caps

Part no.	Description
A100601-17	Cap for male E0400
A100602-17	Cap for female E0400
A201318-1	Cap for male E0200
A201319-1	Cap for female E0200

Compliances, specifications and availability are subject to change without notice.

## Posi-Lok™ parts tools, & accessories

### Product description

Replacement parts, crimping nest and presses

### Molding press parts and vulcanizing accessories

Part no.	Description
A400001	Assembly tool
A100632	Tool for removing contacts from insulators
A100072	Cable cutter - #2 - 4/0 cable
201310	Insulator holding bracket
A201303	Assembly tool for 200A plugs
A200020-3	COM-A-LONG for pulling male contact
A200020-4	COM-A-LONG for pulling female contact
A101208	2 oz. tube silicon grease for lubricating mating end of synthetic rubber insulators

### Crimping nest and presses

Cable size	Crimping nests part no.	Crimping presses (includes crimp nest)
#2-#1	100514-3	A200914-3
1/0-2/0	100514-4	A200914-4
3/0	100514-5	A200914-5
4/0	100514-6	A200914-6

### Other accessories

Connector series no.	Set screw	Copper shim	Pressure pad	Retaining wire
E0200	100012-33	100400-5	N/A	100573-1
E0400	100012-18	100400-8	101214	100573-1



Compliances, specifications and availability are subject to change without notice.