

SECTION

Q

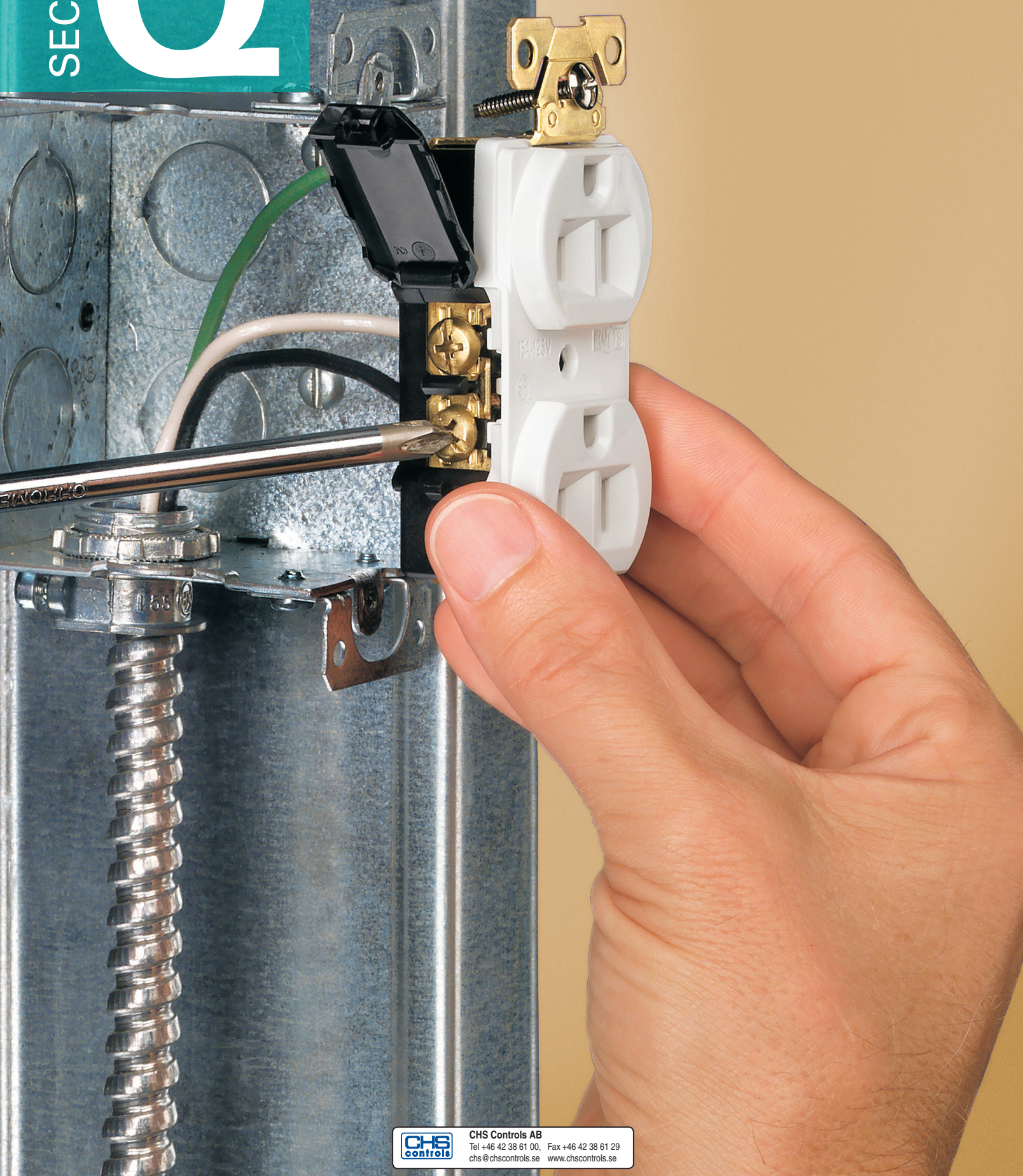

Technical Reference



















RESIDENTIAL | COMMERCIAL | INDUSTRIAL

Table of contents

NEMA configurations	Q-2	Wiring diagrams (continued)	Q-22
15A & 20A straight blade	Q-2	Manual & motion controls	Q-22
30A, 50A, & 60A straight blade	Q-3	AC switches	Q-22
15A, 20A & 30A locking	Q-4, Q-5, Q-6	Dimmers	Q-23, Q-24, Q-25
10A-30A Non-NEMA locking	Q-7	Dimmers & fan speed controls	Q-26, Q-27
50A Non-NEMA locking	Q-7	Occupancy & vacancy sensors	Q-28
		Occupancy & vacancy sensor coverage areas	Q-29
Pin & sleeve & mechanical interlock configurations	Q-8	Timers	Q-29
20A & 30A watertight pin & sleeve	Q-8	Manual contacts & disconnect switches	Q-30
60A & 100A watertight pin & sleeve	Q-9		
16A & 32A watertight pin & sleeve	Q-10	Dimensional data	Q-31
63A & 125A watertight pin & sleeve	Q-11	Switches dimensional data	Q-31
		Enclosures dimensional data	Q-32
Horsepower ratings	Q-12	Lighting control basics	Q-33
For NEMA configurations (plugs & receptacles only)	Q-12	Snap-in receptacle panel cutouts	Q-34
		Attachon lampholder cutouts	Q-34
Common industry information	Q-13		
Organization abbreviations glossary	Q-14	Switch applications	Q-35
Organization acronyms	Q-15	Test requirements	Q-35
Common UL & CSA standards for wiring devices	Q-15	Maximum loads	Q-36
Select NEC® requirements for wiring devices	Q-16		
Wire & cable information	Q-17	Switch applications or materials	Q-37
Wire & cable type abbreviations	Q-17	Chemical resistant properties of common materials	Q-37
Diameter ranges of jacketed cord, per UL62	Q-17		
Wiring diagrams	Q-18	NEMA & IP enclosures	Q-38
By NEMA: 2-pole, 2-wire non-grounding	Q-18	Eaton wiring devices cleaning instructions	Q-38
By NEMA: 2-pole, 3-wire grounding	Q-18	NEMA & IP enclosure ratings	Q-39
By NEMA: 3-pole, 3-wire non-grounding	Q-18	Enclosure type cross reference: NEMA/UL/CSA	Q-40
By NEMA: 3-pole, 4-wire grounding	Q-18, Q-19		
By NEMA: 4-pole, 4-wire non-grounding	Q-19	USMCA/RoHS compliant	Q-41
By NEMA: 4-pole, 5-wire grounding	Q-20	USMCA & RoHS compliant criteria	Q-41
By NEMA: Receptacles & GFCI	Q-21		
By NEMA: Combination devices	Q-21		
Switches	Q-22		

NEMA configurations for select devices

Devices Comply with NEMA WD 1 - General Color Requirements for Wiring Devices and NEMA WD 6 - Wiring Devices Dimensional Specifications

Poles, wires	Rating	NEMA prefix	15A Straight blade		20A Straight blade					
			Receptacle, connector & flanged outlet	Plug & flanged inlet	Receptacle, connector & flanged outlet	Plug & flanged inlet				
2-pole, 2-wire	125V/AC	1	4882 ◇ 736 □	 1-15R	4862 ◆	 1-15P				
2-pole, 3-wire grounding	125V/AC	5	AH5262C □MC TR817 △R AH5252 □ 817 △ 6262 □D 4887 ◇ AHIG5262 □IM TR/WR/BR15 □R AH5269 ◇U TR/CR15 □ AH5269BK ◇U 5262 □M 5261 △M TR6250 △DR 1547 ◇Y 6250 △D 5269N ◇N IG5262 ◇O AH5279C ○ AH8200 □M 5279C ○ 8200 □HM AH5969 ◇O 8210 △M AHTR5262 □R IG8200 □IM 60W47 △Y TR8200 □RM 60W47DPLX □W SGFH15 □GM 15W47 ◇W TRSGFH15 □RGM IG6262 □DI AHTR8200 □R TR6252 □DR 5269NHG ◇N 6252 □D AH8219HG ◇U SGF15 □GM AH8119W ◇O TRSGF15 □RGM AH8219HGC ◇L WRSFG15 □ TR8262 □DR TWRSFG15 □RGM 8262 □D	 5-15R	5266N ◆N AH5266A LA AH5965CR OC 5266NCR NC 5278C ● AH5266 ◇U AH5266BK ◇U AH5965 ◇O 1447 ◇Y 14W47 ◇W 4867 ◆ 5266NHG ◆N AH8215HG ◇U AH8115W ◇O AH8215HGC ◇L AH8215HGA ◆LA AH8215HGAC ◆LA 5266NHG ◆N IG5266NHG ◆NI	 5-15P	AH5362 □MC BR20 □ AH5352 □M CR20 □ 6362 □DM 5362 □M AHIG5362 □IM IG5362 ◇O 1533 ◇Y TR6350 △DR 15W33 ◇W 6350 △D 5361 △M AH8300 □M TR6352 □DR 8300 □M 6352 □D 8310 △M 5369N ◇NC IG8300 □IM 5779C ○ TR8300 □RM AH5779C ○ SGFH20 □GM AH5369 ◇U TRSGFH20 □RGM AHTR5362 □R AHTR8300 □R WRSGF20 □ TR8362 □DR 60W33 △W 8362 □D 60W33DPLX □W 5369NHG ◇N AH5369Y ◇O AH8319HG ◇U IG6362 □DI SGF20 □GM TRBR20 □R TRSGF20 □RGM 4228 ◇	 5-20R	 5-20P	5366N ◆NC AH5778C ● 5366NCR ◆NC 5778C ● AH5366 ◇U AH5364Y ◇O 1433 ◇Y 14W33 ◇W 4409 ◆ 5366NHG ◆N AH8315HG ◇U AH8315HGA ◆LA AH8315HGAC ◆LA
	250V/AC	6	AH5662 □M AH5669 ◇U 5661 △ 60W49 △W AHIG5662 □I 60W49DPLX □W 6662 □D AH5669Y ◇O 1549 ◇Y 826 □ 15W49 ◇W 816 △ IG5661 △I 4227 ◇ 5669N ◇N 5662 □ AH5679C ○ AH8600 □M 5679C ○ 8610 △	 6-15R	5666N ◆N 5678C ● AH5666Y ◇O AH5666 ◇U 1449 ◇Y 14W49 ◇W 4866 ◆ AH8225HG ◇U AH8225HGAC ◆L	 6-15P	AH5462 □M AH5469 ◇L 5461 △ 60W48 △W AHIG5462 □I 60W48DPLX □W 6462 □D AH5469Y ◇O 1548 ◇Y 815 □ 15W48 ◇W 4229 ◇ IG5461 △I 5462 □ 5469N ◇N AH8400 □M 5879C ○ IG8400 □I AH5879C ○ 8410 △	 6-20R	 6-20P	5466N ◆N AH5464Y ◇O 5878C ● AH5878C ● AH5466 ◇U 1448 ◇Y 14W48 ◇W 4509 ◆ AH8325HGAC ◆LA AH8325HG ◆L
	277V/AC	7	5302 □	 7-15R	 7-15P		 7-20R	 7-20P	7624N ◆L	
3-pole, 3-wire	125/250V/AC	10			805 △	 10-20R	 10-20P	9151N ◆L 2836 ◆		
3-pole, 4-wire grounding	125/250V/AC	14			5759 △	 14-20R	 14-20P			
	3Ø 250V/AC	15								
4-pole, 4-wire	3ØY 120/208V/AC	18					 18-20P	7251N ◆L		

Due to spatial constraints not all products are shown on this page. For additional product options in these configurations consult appropriate sections in this buyers guide.

Straight blade legend: How to use the chart

Core catalog number color indicates a device's grade: **BLACK** = Extra heavy-duty industrial specification grade
BLUE = Commercial specification grade

ORANGE = Heavy-duty construction grade
GREEN = Hospital specification grade

A suffix combining a **RED** shape and alpha letter indicate a device's body, type and available options.

Device body:

- Duplex receptacle
- △ Single receptacle
- ◆ Plug;
- ◇ Connector
- Flanged inlet
- Flanged outlet

Open shape has holes (receptacles, connectors, outlets)
Closed shape has blades (plugs, inlets)

Device type:

- A** Angled
- D** Decorator
- G** GFCI
- H** Compact
- I** Isolated ground
- L** Safety grip
- N** Auto grip
- O** Quick grip
- R** Tamper resistant
- S** Surface
- U** Ultra grip

Device options available:

- C** Corrosion resistant
- M** ArrowLink modular
- W** Watertight
- Y** Severe duty insulated

Compliances, specifications and availability are subject to change without notice.

NEMA configurations for select devices

Devices comply with NEMA WD 1 - general color requirements for Wiring Devices and NEMA WD 6 - Wiring Devices Dimensional Specifications

Poles, wires	Rating	NEMA prefix	30A Straight blade		50A Straight blade		60A Straight blade	
			Receptacle, connector & flanged outlet	Plug & flanged inlet	Receptacle, connector & flanged outlet	Plug & flanged inlet	Receptacle, connector & flanged outlet	Plug & flanged inlet
2-pole, 2-wire	125V/AC	1						
	125V/AC	5	6716N ◇N 1233 △ 5716N △	5717AN ◇AN 5717N ◇N 5717NFI ●N S41 ◇A	6711N ◇N 1253 △	5712AN ◇AN 5712N ◇N 5712NFI ●N S41 ◇A		
			5-30R	5-30P	5-50R	5-50P		
2-pole, 3-wire grounding	250V/AC	6	6700N ◇N 5700N △ 1232 △S 1234 △	5701AN ◇AN 5701N ◇N 5701NFI ●N S42 ◇A	6709N ◇N 5709N △ 1252 △S 1254 △	5710AN ◇AN 5710N ◇N 5710NFI ●N S42 ◇A		
	277V/AC	7	6795N ◇N 5795N △	5703AN ◇AN 5703N ◇N 5703NFI ●N	6796N ◇N	5705AN ◇AN 5705N ◇N 5705NFI ●N		
	6-30R	6-30P	6-50R	6-50P				
3-pole, 3-wire	125/250V/AC	10	9341N ◇N 38B △ 125 △S	9352AN ◇AN 9337N ◇N 9337NFI ●N S80 ◇A	4526N ◇N 7985N △ 32B △ 112 △S 122B △	4524N ◇N 4524NFI ●N 7952AN ◇AN S80 ◇A		
	10-30R	10-30P	10-50R	10-50P				
3-pole, 4-wire grounding	125/250V/AC	14	5744N △ 1225 △S 1257 △	5732AN ◇AN 5746N ◇N S21 ◇A	5754N △ 1212 △S 1258 △	5752AN ◇AN 5745N ◇N S21 ◇A	9460N △	9462AN ◇AN 9462N ◇N S20 ◇AN
	14-30R	14-30P	14-50R	14-50P			14-60R	14-60P
3-pole, 4-wire grounding	3Ø 250V/AC	15	8430N △	8432AN ◇AN 8432N ◇N	8450N △	8452AN ◇AN 8452N ◇N	8460N △	AH8462AN ◇AN AH8462N ◇N
	15-30R	15-30P	15-50R	15-50P			15-60R	15-60P
4-pole, 4-wire	3ØY 120/208V/AC	18		8332AN ◇AN 8332N ◇N		8352AN ◇AN 8352N ◇N	5515N △	4516AN ◇N 5517N ◇N S19 ◇A
			18-30R	18-30P	18-50R	18-50P	18-60R	18-60P

Due to spatial constraints not all products are shown on this page. For additional product options in these configurations consult appropriate sections in this buyers guide.

Straight blade legend: How to use the chart

Core catalog number color indicates a device's grade:

BLACK = Extra heavy-duty industrial specification grade
BLUE = Commercial specification grade

ORANGE = Heavy-duty construction grade
GREEN = Hospital specification grade

A suffix combining a **RED** shape and alpha letter indicate a device's body, type and available options.

Device body:

- Duplex receptacle
- △ Single receptacle
- ◆ Plug;
- ◇ Connector
- Flanged inlet
- Flanged outlet

Open shape has holes (receptacles, connectors, outlets)
Closed shape has blades (plugs, inlets)

Device type:

- A Angled
- D Decorator
- G GFCI
- H Compact
- I Isolated ground
- L Safety grip
- N Auto grip
- O Quick grip
- R Tamper resistant
- S Surface
- U Ultra grip

Device options available:















- C Corrosion resistant
- M ArrowLink modular
- W Watertight
- Y Severe duty insulated

Compliances, specifications and availability are subject to change without notice.

Eaton.com
Eaton.com/wiringdevices

CHS controls
CHS Controls AB
Tel +46 42 38 61 00, Fax +46 42 38 61 29
chs@chscontrols.se www.chscontrols.se

Devices Comply with NEMA WD 1 - General Color Requirements
for Wiring Devices and NEMA WD 6 - Wiring Devices Dimensional Specifications

Poles, wires	Rating	NEMA prefix	15A Locking				
			Receptacle, connector & flanged outlet		Plug & flanged inlet		
2-pole, 2-wire	125V/AC	ML1	7464N ◇ 7427N ◇ 7468 ○		7465N ◆ 7428N ◆ 7479N ◆	7429N ◆ 7466 ● 7467 ●	
	125V/AC	L1	CWL115FO ○ 7506 ◇ 7540 □ CWL115R △		CWL115FI ● 7546 ◆ 7548 ◆		
	250V/AC	L2					
2-pole, 3-wire grounding	125V/AC	ML2	7593 ◇ 7596 ○ 7596N ○		7594 ◆ 7595 ● 7595N ●		
	125V/AC	L5	CWL515C ◇L CWL515CAN ◇AL CWL515FO ○ CWL515R △ IG4700 □I IGL515R △I 65W47 △W 65W47DPLX □W 25W47 ◇W 4731NCR ◇CN CR4700 □C 4700 □ 4731N ◇N 5792 □ CR5792 □C		CWL515FI ● CWL515P ◆L CWL515PAN ◆AL 24W47 ◆W 4721N ◆N 4721NCR ◆CN		
	250V/AC	L6	CWL615C ◇L CWL615FO ○ CWL615R △ 65W49DPLX □W IGL615R △I 25W49 ◇W 6566N ◇N 65W49 △W 6580 □		CWL615FI ● CWL615P ◆L 24W49 ◆W 6565N ◆N		
	277V/AC	L7	CWL715C ◇L 4750 □ CWL715R △ 2534 ◇Y 25W34 ◇W CWL715FO ○ 65W34 △W 65W34DPLX □W 4772N ◇N		CWL715FI ● CWL715P ◆L 24W34 ◆W 4771N ◆N		
	480V/AC	L8					
	600V/AC	L9					
3-pole, 3-wire	125/250V/AC	ML3	7484 ◇ 7487 ○ 7487N ○		7485 ◆ 7486 ● 7486N ●		
	125/250V/AC	L10					
	3Ø 250V/AC	L11					
	3Ø 480V/AC	L12					
	3Ø 600V/AC	L13					

Locking device legend: How to use the chart

Core catalog number color indicates a device's grade:

BLACK = Extra heavy-duty industrial specification grade

A suffix combining a **RED** shape and alpha letter indicate a device's body, type and available options.

Device body:

- Duplex receptacle
- ◆ Plug
- ◇ Connector
- △ Single receptacle
- Flanged inlet
- Flanged outlet
- Open shape** has holes (receptacles, connectors, outlets)
- Closed shape** has blades (plugs, inlets)







































Device type:

- A** Angled
- C** Corrosion resistant
- I** Isolated ground
- L** Safety grip
- N** Auto grip
- P** Pro grip
- U** Ultra grip
- W** Watertight
- Z** With lid or cover

Compliances, specifications and availability are subject to change without notice.

NEMA configurations for select devices

Devices comply with NEMA WD 1 - general color requirements for Wiring Devices and NEMA WD 6 - Wiring Devices Dimensional Specifications

Poles, wires	Rating	NEMA prefix	20A Locking		30A Locking					
			Receptacle, connector & flanged outlet	Plug & flanged inlet	Receptacle, connector, & flanged outlet	Plug & flanged inlet				
2-pole, 2-wire	125V/AC	ML1								
	125V/AC	L1								
	250V/AC	L2	CWL220C ◊L CWL220FO ○ CWL220R △	 L2-20R	CWL220P ◆L CWL220P-6 ◆ZL	 L2-20P				
2-pole, 3-wire grounding	125V/AC	ML2								
	125V/AC	L5	AHCL520C ◊U L520CW ◊W AHCL520FO ○ L520RW △W AHL520CBK ◊U CRL520C ◊CL AHCL520R △ CRL520R △C AHIGL520R △ I	 L5-20R	AHCL520FI ● AHCL520P ◆U AHL520PBK ◆U L520PW ◆W CRL520P ◆CL	 L5-20P	AHCL530FO ○ L530RW △W AHCL530R △ CRL530C ◊CL AHCL530C ◊U CRL530R △C AHIGL530R △ I L530CW ◊W	 L5-30R	AHCL530FI ● AHCL530P ◆U AHIGL530P ◆IU L530PW ◆W CRL530P ◆CL	 L5-30P
	240V/AC	L25			AHL2530C ◊ AHL2530R △ IGL2530R △	 L25-30R		AHL2530P ◆	 L25-30P	
	250V/AC	L6	AHCL620C ◊U L620CW ◊W AHCL620R △ L620RW △W AHCL620FO ○ CRL620R △C AHIGL620R △ I CRL620C ◊CL	 L6-20R	AHCL620FI ● AHCL620P ◆U L620PW ◆W CRL620P ◆CL	 L6-20P	AHCL630C ◊U L630CW ◊W AHCL630R △ CRL630C ◊CL AHCL630FO ○ CRL630R △C AHIGL630R △ I CRL630R △C	 L6-30R	AHCL630FI ● AHCL630P ◆U L630PW ◆W CRL630P ◆CL	 L6-30P
	277V/AC	L7	AHCL720C ◊U AHIGL720R △ I AHCL720FO ○ L720CW ◊W AHCL720R △ L720RW △W	 L7-20R	AHCL720FI ● AHCL720P ◆U L720PW ◆W	 L7-20P	AHCL730C ◊U AHIGL730R △ I AHCL730R △ L730CW ◊W AHCL730FO ○ L730RW △W	 L7-30R	AHCL730FI ● AHCL730P ◆U L730PW ◆W	 L7-30P
	347V/AC	L24	L2420R △	 L24-20R	L2420P ◆	 L24-20P				
	480V/AC	L8	AHCL820C ◊U AHIGL820R △ I AHCL820R △ L820RW △W AHCL820FO ○ L820CW ◊W	 L8-20R	AHCL820FI ● AHCL820P ◆U L820PW ◆W	 L8-20P	AHCL830C ◊U AHIGL830R △ I AHCL830R △ L830CW ◊W AHCL830FO ○ L830RW △W	 L8-30R	AHCL830FI ● AHCL830P ◆U L830PW ◆W	 L8-30P
	600V/AC	L9	CWL920C ◊ CWL920FO ○ CWL920R △	 L9-20R	CWL920FI ● CWL920P ◆	 L9-20P	CWL930C ◊ CWL930FO ○ CWL930R △	 L9-30R	CWL930FI ● CWL930P ◆	 L9-30P
	3-pole, 3-wire	125/250V/AC	ML3							
		125/250V/AC	L10	AHCL1020FO ○ L1020RW △W AHCL1020C ◊U L1020CW ◊W AHCL1020R △	 L10-20R	AHCL1020FI ● AHCL1020P ◆U L1020PW ◆W	 L10-20P	AHCL1030FO ○ L1030CW ◊W AHCL1030C ◊U L1030RW △W AHCL1030R △	 L10-30R	AHCL1030FI ● AHCL1030P ◆U L1030PW ◆W
3Ø 250V/AC		L11	AHCL1120FO ○ L1120RW △W AHCL1120C ◊U L1120CW ◊W AHCL1120R △	 L11-20R	AHCL1120FI ● AHCL1120P ◆U L1120PW ◆W	 L11-20P	AHCL1130FO ○ L1130CW ◊W AHCL1130C ◊U L1130RW △W AHCL1130R △	 L11-30R	AHCL1130FI ● AHCL1130P ◆U L1130PW ◆W	 L11-30P
3Ø 480V/AC		L12	CWL1220C ◊ CWL1220FO ○ CWL1220R △	 L12-20R	CWL1220FI ● CWL1220P ◆	 L12-20P	CWL1230C ◊ CWL1230FO ○ CWL1230R △	 L12-30R	CWL1230FI ● CWL1230P ◆	 L12-30P
3Ø 600V/AC		L13			CWL1330C ◊ CWL1330FO ○ CWL1330R △	 L13-30R	CWL1330FI ● CWL1330P ◆	 L13-30P		

Locking device legend: How to use the chart

Core catalog number color indicates a device's grade:

BLACK = Extra heavy-duty industrial specification grade

A suffix combining a **RED** shape and alpha letter indicate a device's body, type and available options.

Device body:

- ◆ Duplex receptacle
- ◇ Plug
- ◇ Connector
- △ Single receptacle
- Flanged inlet
- Flanged outlet

Open shape has holes (receptacles, connectors, outlets)
Closed shape has blades (plugs, inlets)

Device type:

- A Angled
- C Corrosion resistant
- I Isolated ground
- L Safety grip
- N Auto grip
- P Pro grip
- U Ultra grip
- W Watertight
- Z With lid or cover

Compliances, specifications and availability are subject to change without notice.

Devices Comply with NEMA WD 1 - General Color Requirements
for Wiring Devices and NEMA WD 6 - Wiring Devices Dimensional Specifications

Poles, wires	Rating	NEMA prefix	20A Locking		30A Locking					
			Receptacle, connector & flanged outlet	Plug & flanged inlet	Receptacle, connector, & flanged outlet	Plug & flanged inlet				
3-pole, 4-wire grounding	125/250V/AC	L14	AHCL1420C ◇U L1420CW ◇W AHL1420C ◇U CRL1420C ◇CL AHL1420FO ○ CRL1420R △C AHL1420FOBK ○ L1420RW △W AHCL1420R △ 6406BK ○ IGL1420R △I	AHCL1420FI ● AHCL1420PBK ◆U AHL1420FIBK ● AHCL1420P ◆U L1420PW ◆W CRL1420P ◆CL 6405BK ●	AHCL1430C ◇U L1430RW △W AHCL1430R △ CRL1430C ◇CL AHCL1430FO ○ CRL1430R △C AHIGL1430R △I L1430CW ◇W	AHCL1430FI ● CRL1430P ◆CL AHCL1430P ◆U L1430PW ◆W 6512BK ◆				
	3Ø 250V/AC	L15	AHCL1520C ◇U L1520CW ◇W AHL1520CBK ◆U L1520RW △W AHCL1520FO ○ CRL1520C ◇CL AHIGL1520R △I CRL1520R △C AHCL1520R △	AHCL1520FI ● AHCL1520P ◆U AHL1520PBK ◆U L1520PW ◆W CRL1520P ◆CL	AHCL1530C ◇U L1530CW ◇W AHCL1530R △ L1530RW △W AHCL1530FO ○ CRL1530C ◇CL AHIGL1530R △I	CRL1530P ◆CL AHCL1530FI ● AHCL1530P ◆U L1530PW ◆W				
	3Ø 480V/AC	L16	AHCL1620C ◇U CRL1620C ◇CL AHCL1620FO ○ AHL1620CBK ◆U AHCL1620R △ AHIGL1620R △I L1620CW ◇W L1620RW △W	AHCL1620FI ● AHCL1620P ◆U AHL1620PBK ◆U L1620PW ◆W CRL1620P ◆CL AHL1620FI ●	AHCL1630C ◇U AHCL1630R △ AHCL1630FO ○ L1630CW ◇W L1630RW △W	CRL1630P ◆CL AHCL1630FI ● AHCL1630P ◆U L1630PW ◆W				
	3Ø 600V/AC	L17			AHCL1730C ◇U L1730CW ◇W AHCL1730R △ L1730RW △W AHCL1730FO ○	AHCL1730P ◆U AHCL1730FI ● L1730PW ◆W				
4-pole, 4-wire	3ØY 120/208V/AC	L18	AHCL1820C ◇U L1820CW ◇W AHCL1820FO ○ L1820RW △W AHCL1820R △ AHL1820FO ○	AHCL1820FI ● AHCL1820P ◆U L1820PW ◆W	AHCL1830C ◇U L1830CW ◇W AHCL1830R △ L1830RW △W AHCL1830FO ○	AHCL1830P ◆U AHCL1830FI ● L1830PW ◆W				
	3ØY 277/480V/AC	L19	AHCL1920C ◇U L1920CW ◇W AHCL1920FO ○ L1920RW △W AHCL1920R △	AHCL1920FI ● AHCL1920P ◆U L1920PW ◆W	AHCL1930C ◇U L1930CW ◇W AHCL1930R △ L1930RW △W AHCL1930FO ○	AHCL1930P ◆U AHCL1930FI ● L1930PW ◆W				
	3ØY 347/600V/AC	L20	AHCL2020C ◇U L2020CW ◇W AHCL2020FO ○ L2020RW △W AHCL2020R △	AHCL2020FI ● AHCL2020P ◆U L2020PW ◆W	AHCL2030C ◇U L2030CW ◇W AHCL2030R △ L2030RW △W AHCL2030FO ○	AHCL2030P ◆U AHCL2030FI ● L2030PW ◆W				
4-pole, 5-wire grounding	3ØY 120/208V/AC	L21	AHCL2120C ◇U AHL2120CBK ◆U AHCL2120FO ○ AHL2120CF ◆U AHCL2120R △ L2120RW △W AHIGL2120R △I L2120CW ◇W	AHCL2120FI ● AHCL2120P ◆U AHL2120PBK ◆U L2120PW ◆W AHL2120PF ◆L	AHCL2130C ◇U AHL2130FO ○ AHCL2130R △ AHIGL2130R △I L2130CW ◇W L2130RW △W L2130PF ◆L AHL2130CF ◆U	AHCL2130FI ● AHCL2130P ◆U L2130PW ◆W L2130PF ◆L				
	3ØY 240/415V	L26			AHCL2630C ◇ AHCL2630R △ IGL2630R △	AHL2630P ◆				
	3ØY 277/480V/AC	L22	AHCL2220C ◇U L2220CW ◇W AHCL2220R △ L2220RW △W AHIGL2220R △I AHCL2220FO ○	AHCL2220FI ● AHCL2220P ◆U L2220PW ◆W	AHCL2230C ◇U L2230CW ◇W AHCL2230R △ L2230RW △W AHIGL2230R △I L22230CF ◆L AHCL2230FO ○	AHCL2230FI ● AHCL2230P ◆U L2230PW ◆W L2230PF ◆L				
	347/600V/AC	L23	AHCL2320C ◇U AHCL2320FO ○ AHCL2320R △ L2320CW ◇W AHIGL2320R △I L2320RW △W	AHCL2320FI ● AHCL2320P ◆U L2320PW ◆W	AHCL2330C ◇U AHCL2330FO ○ AHCL2330R △ AHIGL2330R △I L2330CW ◇W L2330RW △W	AHCL2330FI ● AHCL2330P ◆U L2330PW ◆W				

Locking device legend: How to use the chart

Core catalog number color indicates a device's grade:

BLACK = Extra heavy-duty industrial specification grade

A suffix combining a **RED** shape and alpha letter indicate a device's body, type and available options.

Device body:

- Duplex receptacle
 - ◆ Plug
 - ◇ Connector
 - △ Single receptacle
 - Flanged inlet
 - Flanged outlet
- Open shape** has holes (receptacles, connectors, outlets)
Closed shape has blades (plugs, inlets)

Device type:

- A Angled
- C Corrosion resistant
- I Isolated ground
- L Safety grip
- N Auto grip
- P Pro grip
- U Ultra grip
- W Watertight
- Y Severe duty insulated
- Z With lid or cover

Compliances, specifications and availability are subject to change without notice.

NEMA configurations for select devices

Devices comply with NEMA WD 1 - general color requirements for Wiring Devices and NEMA WD 6 - Wiring Devices Dimensional Specifications

Poles, wires	Rating	10A - 30A Non-NEMA locking	
		Receptacle, connector, & flanged outlet	Plug & flanged inlet
3-pole, 3-wire	10/15A 125/250V/AC	4755 ◊L 7565N ◊N 7580 □ 7582 △ 	4767 ◆L 4767AN ◆AL 7567N ◆N
	20A 125/250V/AC	7310B △ 7314C ◊L 7314CW ◊W 7314RW △W 7328N ○ 	7327N ● 9965C ◆L 9965PW ◆W
	30A 125/250V/AC	AH3330-2 △ 3333CW ◊W 3333RW △W AH3333N ◊U AH3336N ○ 	AH3331N ◆U 3331PW ◆W 3337N ●
4-pole, 4-wire	20A 3Ø 120/208V/AC	7409N ○ 7410B △ 7413C ◊L 7413CW ◊W 7413RW △W 	7408N ● 7411C ◆L 7411PW ◆W
	30A 3Ø 120/208V/AC	3430 △ 3433CW ◊W AH3433N ◊U 3433RW △W 3436N ○ 	AH3431N ◆U 3431PW ◆W 3434N ●
4-P, 5-W grounding	20/10A 250/600V/AC	AH3523BK ◊U 3525BK ○ 	AH3521BK ◆U 3524BK ●

Poles, wires	Rating	50A Non-NEMA locking	
		Receptacle & connector	Plug, flanged inlets & hull inlet
2-pole, 3-wire grounding	125V/AC Marine corrosion resistant	63CR60EX ◊P 63CR60 ◊T 63CR70 △ 	63CR61EX ◆P 63CR61 ◆T
	125V/AC California standard	CS6360EX ◊P CS6360 ◊T CS6370 △ 	CS6361EX ◆P CS6361 ◆T CS6377 ● CS6378 ●Z
	250V/AC California standard	CS8264EX ◊P CS8264 ◊T CS8269 △ 	CS8265EX ◆P CS8265 ◆T CS8275 ● CS8277 ●Z
	250V/DC 600V/AC	3762EX ◊P 3762 ◊T 3771 △ 	3763EX ◆P 3763 ◆T 3777 ● 3767 ●Z
	480V/AC California standard	CS8464EX ◊P CS8464 ◊T CS8469 △ 	CS8465EX ◆P CS8465 ◆T CS8475 ● CS8477 ●Z
3-pole, 4-wire grounding	125/250V/AC Marine corrosion resistant	63CR64EX ◊P 63CR64 ◊T 63CR69 △ 	63CR65EX ◆P 63CR65 ◆T
	125/250V/AC California standard	CS6364EX ◊P CS6364 ◊T CS6369 △ 	CS6365EX ◆P CS6365 ◆T CS6375 ● CS6376 ●Z
	3Ø 250V/AC California standard	CS8364EX ◊P CS8364 ◊T CS8369 △ 	CS8365EX ◆P CS8365 ◆T CS8375 ● CS8377 ●Z
	250V/DC 600V/AC	3764EX ◊P 3764 ◊T 3769 △ 	3765EX ◆P 3765 ◆T 3775 ● 3768 ●Z
	250V/DC 600V/AC	7764EX ◊P 7764 ◊T 7379 △ 	7765EX ◆P 7765 ◆T 7958 ● 7968 ●Z
3Ø 480V/AC California standard	CS8164EX ◊P CS8164 ◊T CS8169 △ 	CS8165EX ◆P CS8165 ◆T CS8175 ● CS8177 ●Z 	

Locking device legend: How to use the chart

Core catalog number color indicates a device's grade:

BLACK = Extra heavy-duty industrial specification grade

A suffix combining a **RED** shape and alpha letter indicate a device's body, type and available options.

Device body:

- Duplex receptacle
- ◆ Plug
- ◊ Connector
- △ Single receptacle
- Flanged inlet
- Flanged outlet

Open shape has holes (receptacles, connectors, outlets)
Closed shape has blades (plugs, inlets)

Device type:

- A Angled
- C Corrosion resistant
- I Isolated ground
- L Safety grip
- N Auto grip
- P Pro grip
- U Ultra grip
- W Watertight
- Y Severe duty insulated
- Z With lid or cover

Compliances, specifications and availability are subject to change without notice.

Poles, wires	Rating	20A Watertight pin & sleeve		30A Watertight pin & sleeve	
		Receptacle, connector & mechanical interlocks	Plug & inlet	Receptacle, connector & mechanical interlocks	Plug & inlet
2-pole, 3-wire grounding	125V	CD320HMI4W >QX AH320R4W Δ AH320C4W ◇	AH320P4W ◆ AH320B4W ●	CD330MI4W >Q AH330R4W Δ AH330C4W ◇	AH330P4W ◆ AH330B4W ●
	250V	CD320HMI6W >QX AH320R6W Δ AH320C6W ◇	AH320P6W ◆ AH320B6W ●	CD330MI6W >Q CD330MIF6W >E AH330R6W Δ AH330C6W ◇	AH330P6W ◆ AH330B6W ●
	480V/AC	CD320HMI7W >QX AH320R7W Δ AH320C7W ◇	AH320P7W ◆ AH320B7W ●	CD330MI7W >Q AH330R7W Δ AH330C7W ◇	AH330P7W ◆ AH330B7W ●
3-pole, 4-wire grounding	125/250V/AC	CD420HMI12W >QX AH420R12W Δ AH420C12W ◇	AH420P12W ◆ AH420B12W ●	CD430MI12W >Q AH430R12W Δ AH430C12W ◇	AH430P12W ◆ AH430B12W ●
	3Ø 250V/AC	CD420HMI9W >QX AH420R9W Δ AH420C9W ◇	AH420P9W ◆ AH420B9W ●	CD430MI9W >Q CD430MIB9W >F CD430MICB9W >B CD430MIF9W >E AH430R9W Δ AH430C9W ◇	AH430P9W ◆ AH430B9W ●
	3Ø 480V/AC	CD420HMI7W >QX CD420MIB7W >F CD420MICB7W >B AH420R7W Δ AH420C7W ◇	AH420P7W ◆ AH420B7W ●	CD430MI7W >Q CD430MIB7W >F CD430MICB7W >B CD430MIF7W >E AH430R7W Δ AH430C7W ◇	AH430P7W ◆ AH430B7W ●
	3Ø 600V/AC	CD420HMI5W >QX AH420R5W Δ AH420C5W ◇	AH420P5W ◆ AH420B5W ●	CD430MI5W >Q CD430MIF5W >E AH430R5W Δ AH430C5W ◇	AH430P5W ◆ AH430B5W ●
4-pole, 5-wire grounding	3ØY 120/208V/AC	CD520HMI9W >QX AH520R9W Δ AH520C9W ◇	AH520P9W ◆ AH520B9W ●	CD530MI9W >Q AH530R9W Δ AH530C9W ◇	AH530P9W ◆ AH530B9W ●
	3ØY 277/480V/AC	AH520R7W Δ AH520C7W ◇	AH520P7W ◆ AH520B7W ●	CD530MI7W >Q AH530R7W Δ AH530C7W ◇	AH530P7W ◆ AH530B7W ●
	3ØY 347/600V/AC	AH520R5W Δ AH520C5W ◇	AH520P5W ◆ AH520B5W ●	CD530MI5W >Q AH530R5W Δ AH530C5W ◇	AH530P5W ◆ AH530B5W ●

Locking device legend: How to use the chart

Core catalog number color indicates a device's grade:

BLACK = Extra heavy-duty industrial specification grade

A suffix combining a **RED** shape and alpha letter indicate a device's body, type and available options.

Device body:

- Duplex receptacle
- ◆ Plug
- ◇ Connector

- Flanged inlet
- Flanged outlet

Open shape has holes (receptacles, connectors, outlets)
Closed shape has blades (plugs, inlets)

Device type:

- A** Angled
- B** Circuit breaker option
- E** Fusible
- F** Fuse option
- Q** Non-fusible
- X** Horizontal

Compliances, specifications and availability are subject to change without notice.

Pin & sleeve and mechanical interlock configurations

North American Standard Amp Rating

Poles, wires	Rating	60A Watertight pin & sleeve		100A Watertight pin & sleeve	
		Receptacle, connector & mechanical interlocks	Plug & inlet	Receptacle, connector & mechanical interlocks	Plug & inlet
2-pole, 3-wire grounding	125V	AH360R4W Δ AH360C4W \diamond	AH360P4W \blacklozenge AH360B4W \bullet	AH3100R4W Δ AH3100C4W \diamond	AH3100P4W \blacklozenge AH3100B4W \bullet
	250V	CD360MI6W \blacktriangleright \mathbf{Q} CD360MIF6W \blacktriangleright \mathbf{E} AH360R6W Δ AH360C6W \diamond	AH360P6W \blacklozenge AH360B6W \bullet	CD3100MI6W \blacktriangleright \mathbf{Q} AH3100R6W Δ AH3100C6W \diamond	AH3100P6W \blacklozenge AH3100B6W \bullet
	480V/AC	CD360MI7W \blacktriangleright \mathbf{Q} AH360R7W Δ AH360C7W \diamond	AH360P7W \blacklozenge AH360B7W \bullet	CD3100MI7W \blacktriangleright \mathbf{Q} AH3100R7W Δ AH3100C7W \diamond	AH3100P7W \blacklozenge AH3100B7W \bullet
3-pole, 4-wire grounding	125/250V/AC	CD460MI12W \blacktriangleright \mathbf{Q} AH460R12W Δ AH460C12W \diamond	AH460P12W \blacklozenge AH460B12W \bullet	CD4100MI12W \blacktriangleright \mathbf{Q} AH4100R12W Δ AH4100C12W \diamond AH4100R12W-15 Δ \mathbf{A}	AH4100P12W \blacklozenge AH4100B12W \bullet
	3 \emptyset 250V/AC	CD460MI9W \blacktriangleright \mathbf{Q} CD460MICB9W \blacktriangleright \mathbf{B} CD460MIF9W \blacktriangleright \mathbf{E} AH460R9W Δ AH460C9W \diamond	AH460P9W \blacklozenge AH460B9W \bullet	CD4100MI9W \blacktriangleright \mathbf{Q} AH4100R9W Δ AH4100C9W \diamond	AH4100P9W \blacklozenge AH4100B9W \bullet
	3 \emptyset 480V/AC	CD460MI7W \blacktriangleright \mathbf{Q} CD460MIB7W \blacktriangleright \mathbf{F} CD460MICB7W \blacktriangleright \mathbf{B} CD460MIF7W \blacktriangleright \mathbf{E} AH460R7W Δ AH460C7W \diamond	AH460P7W \blacklozenge AH460B7W \bullet	CD4100MI7W \blacktriangleright \mathbf{Q} AH4100R7W Δ AH4100C7W \diamond AH4100R7W-15 Δ \mathbf{A}	AH4100P7W \blacklozenge AH4100B7W \bullet
	3 \emptyset 600V/AC	CD460MI5W \blacktriangleright \mathbf{Q} CD460MICB5W \blacktriangleright \mathbf{B} CD460MIF5W \blacktriangleright \mathbf{E} AH460R5W Δ AH460C5W \diamond	AH460P5W \blacklozenge AH460B5W \bullet	CD4100MI5W \blacktriangleright \mathbf{Q} AH4100R5W Δ AH4100C5W \diamond AH5100R9W-15 Δ \mathbf{A}	AH4100P5W \blacklozenge AH4100B5W \bullet
4-pole, 5-wire grounding	3 \emptyset Y 120/208V/AC	CD560MI9W \blacktriangleright \mathbf{Q} CD560MIF9W \blacktriangleright \mathbf{E} AH560R9W Δ AH560C9W \diamond AH560R9W-15 Δ \mathbf{A}	AH560P9W \blacklozenge AH560B9W \bullet	CD5100MI9W \blacktriangleright \mathbf{Q} AH5100R9W Δ AH5100C9W \diamond	AH5100P9W \blacklozenge AH5100B9W \bullet
	3 \emptyset Y 277/480V/AC	CD560MI7W \blacktriangleright \mathbf{Q} CD560MIF7W \blacktriangleright \mathbf{E} AH560R7W Δ AH560C7W \diamond	AH560P7W \blacklozenge AH560B7W \bullet	CD5100MI7W \blacktriangleright \mathbf{Q} AH5100R7W Δ AH5100C7W \diamond AH5100R7W-15 Δ \mathbf{A}	AH5100P7W \blacklozenge AH5100B7W \bullet
	3 \emptyset Y 347/600V/AC	CD560MI5W \blacktriangleright \mathbf{Q} CD560MIF5W \blacktriangleright \mathbf{E} AH560R5W Δ AH560C5W \diamond	AH560P5W \blacklozenge AH560B5W \bullet	AH5100R5W Δ AH5100C5W \diamond	AH5100P5W \blacklozenge AH5100B5W \bullet

Locking device legend: How to use the chart

Core catalog number color indicates a device's grade:

BLACK = Extra heavy-duty industrial specification grade

A suffix combining a **RED** shape and alpha letter indicate a device's body, type and available options.

Device body:

- \square Duplex receptacle
- \blacklozenge Plug
- \diamond Connector
- \bullet Flanged inlet
- \blacktriangleright Mechanical interlock

Open shape has holes (receptacles, connectors, outlets)
Closed shape has blades (plugs, inlets)

Device type:

- A** Angled
- B** Circuit breaker option
- E** Fusible
- F** Fuse option
- Q** Non-fusible
- X** Horizontal

Compliances, specifications and availability are subject to change without notice.

Poles, wires	Rating	16A Watertight pin & sleeve		32A Watertight pin & sleeve	
		Receptacle & connector	Plug & inlet	Receptacle & connector	Plug & inlet
2-pole, 3-wire grounding	110-130V	AH316R4W △ AH316C4W ◇	AH316P4W ◆ AH316B4W ●	AH332R4W △ AH332C4W ◇	AH332P4W ◆ AH332B4W ●
	220-240V	AH316R6W △ AH316C6W ◇	AH316P6W ◆ AH316B6W ●	AH332R6W △ AH332C6W ◇	AH332P6W ◆ AH332B6W ●
3-pole, 4-wire grounding	380V, 50Hz 440V, 60Hz			AH332R3W △ AH332C3W ◇	AH332P3W ◆ AH332B3W ●
	380-415V	AH416R6W △ AH416C6W ◇	AH416P6W ◆ AH416B6W ●	AH432R6W △ AH432C6W ◇	AH432P6W ◆ AH432B6W ●
4-pole, 5-wire grounding	220/380 240/415	AH516R6W △ AH516C6W ◇	AH516P6W ◆ AH516B6W ●	AH532R6W △ AH532C6W ◇	AH532P6W ◆ AH532B6W ●

Locking device legend: How to use the chart

Core catalog number color indicates a device's grade:

BLACK = Extra heavy-duty industrial specification grade

Device body:

- △ Single receptacle
- ◆ Plug
- ◇ Connector

- Flanged inlet

Open shape has holes (receptacles, connectors, outlets)
Closed shape has blades (plugs, inlets)

Compliances, specifications and availability are subject to change without notice.

Pin & sleeve configurations

International Standard Amp Rating

Poles, wires	Rating	63A Watertight pin & sleeve		125A Watertight pin & sleeve	
		Receptacle & connector	Plug & inlet	Receptacle & connector	Plug & inlet
2-pole, 3-wire grounding	220-240V	AH363R6W Δ AH363C6W \diamond 	AH363P6W \blacklozenge AH363B6W \bullet 	AH3125R6W Δ AH3125C6W \diamond 	AH3125P6W \blacklozenge AH3125B6W \bullet
3-pole, 4-wire grounding	380-415V	AH463R6W Δ AH463C6W \diamond 	AH463P6W \blacklozenge AH463B6W \bullet 	AH4125R6W Δ AH4125C6W \diamond 	AH4125P6W \blacklozenge AH4125B6W \bullet
4-pole, 5-wire grounding	220/380 240/415	AH563R6W Δ AH563C6W \diamond 	AH563P6W \blacklozenge AH563B6W \bullet 	AH5125R6W Δ AH5125C6W \diamond 	AH5125P6W \blacklozenge AH5125B6W \bullet

Locking device legend: How to use the chart

Core catalog number color indicates a device's grade:

BLACK = Extra heavy-duty industrial specification grade

Device body:

- Δ Single receptacle
- \blacklozenge Plug
- \diamond Connector
- \bullet Flanged inlet

Open shape has holes (receptacles, connectors, outlets)
Closed shape has blades (plugs, inlets)

Compliances, specifications and availability are subject to change without notice.

NEMA configurations (plugs & receptacles only)

Straight blade configurations

NEMA	AC HP rating	Rating
1-15	0.5	15A-125V
2-15	1.5*	15A-250V
2-20	2*	20A-250V
2-30	2*	30A-250V
5-15	0.5	15A-125V
5-20	1	20A-125V
5-30	2	30A-125V
5-50	2	50A-125V
6-15	1.5*	15A-250V
6-20	2*	20A-250V
6-30	2*	30A-250V
6-50	3*	50A-250V
7-15	2	15A-277V/AC only
7-20	2	20A-277V/AC only
7-30	3	30A-277V/AC only
7-50	5	50A-277V/AC only
10-20	2L-L*/1 L-N	20A-125/250V
10-30	2 L-L*/2 L-N	30A-125/250V
10-50	3 L-L*/2 L-N	50A-125/250V
11-15	2	15A-3Ø 250V
11-20	3	20A-3Ø 250V
11-30	3	30A-3Ø 250V
11-50	7.5	50A-3Ø 250V
14-15	1.5 L-L*/0.5 L-N	15A-125/250V
14-20	2 L-L*/1 L-N	20A-125/250V
14-30	2 L-L*/2 L-N	30A-125/250V
14-50	3 L-L*/2 L-N	50A-125/250V
14-60	3 L-L*/2 L-N	60A-125/250V
15-15	2	15A-3Ø 250V
15-20	3	20A-3Ø 250V
15-30	3	30A-3Ø 250V
15-50	7.5	50A-3Ø 250V
15-60	10	60A-3Ø 250V
18-15	2	15A-3ØY 120/208V
18-20	2	20A-3ØY 120/208V
18-30	3	30A-3ØY 120/208V
18-50	7.5	50A-3ØY 120/208V
18-60	7.5	60A-3ØY 120/208V

L-L denotes phase-to-phase HP rating
 L-N denotes phase-to-neutral HP rating
 *Suitable for 208V motor applications at HP rating

Locking configurations

NEMA	AC HP rating	Rating
L1-15	0.5	15A-125V
L2-20	2*	20A-250V
L5-15	0.5	15A-125V
L5-20	1	20A-125V
L5-30	2	30A-125V
L6-15	1.5*	15A-250V
L6-20	2*	20A-250V
L6-30	2*	30A-250V
L7-15	2	15A-277V/AC only
L7-20	2	20A-277V/AC only
L7-30	3	30A-277V/AC only
L8-20	3	20A-480V/AC only
L8-30	5	30A-480V/AC only
L9-20	NA	20A-600V/AC only
L9-30	NA	30A-600V/AC only
L10-20	2 L-L*/1 L-N	20A-125/250V
L10-30	2 L-L*/2 L-N	30A-125/250V
L11-15	2	15A-3Ø 250V
L11-20	3	20A-3Ø 250V
L11-30	3	30A-3Ø 250V
L12-20	5	20A-3Ø 480V
L12-30	10	30A-3Ø 480V
L13-30	NA	30A-3Ø 600V
L14-20	2L-L*/1 L-N	20A-125/250V
L14-30	2 L-L*/2 L-N	30A-125/250V
L15-20	3	20A-3Ø 250V
L15-30	3	30A-3Ø 250V
L16-20	5	20A-3Ø 480V
L16-30	10	30A-3Ø 480V
L17-30	NA	30A-3Ø 600V
L18-20	2	20A-3ØY 120/208V
L18-30	3	30A-3ØY 120/208V
L19-20	5	20A-3ØY 277/480V
L19-30	10	30A-3ØY 277/480V
L20-20	NA	20A-3ØY 347/600V
L20-30	NA	30A-3ØY 347/600V
L21-20	2	20A-3ØY 120/208V
L21-30	3	30A-3ØY 120/208V
L22-20	5	20A-3ØY 277/480V
L22-30	10	30A-3ØY 277/480V
L23-20	NA	20A-3ØY 347/600V
L23-30	NA	30A-3ØY 347/600V
L24-20	NA	20A-347V/AC
L25-30	NA	30A-240V/AC
L26-30	NA	30A-3ØY 240/415V/AC

L-L denotes phase-to-phase HP rating
 L-N denotes phase-to-neutral HP rating
 *Suitable for 208V motor applications at HP rating

Compliances, specifications and availability are subject to change without notice.

Common Industry Information



CHS Controls AB
Tel +46 42 38 61 00, Fax +46 42 38 61 29
chs@chscontrols.se www.chscontrols.se

Organization abbreviations glossary

Common abbreviations for organizations often referred to in the electrical industry, and also noted throughout the Arrow Hart catalog

ANSI

American National Standards Institute, Inc.

ANSI is a private, non-profit organization that administers and coordinates the U.S. voluntary standardization and conformity assessment system. The Institute's mission is to enhance both the global competitiveness of U.S. business and the U.S. quality of life by promoting and facilitating voluntary consensus standards and conformity assessment systems and safeguarding their integrity.

www.ansi.org

CEC Title 24

California Energy Commission's Energy Efficiency Standards for Residential and Nonresidential Buildings

Part of the California State Building Code, Title 24 requires a minimum level of energy efficiency for all new heated or cooled structures, including additions and alterations to existing homes and most commercial buildings. Energy efficient lighting and controls must be incorporated per the current standards. Energy-efficient lighting fixtures are required as well as the use of dimmers and vacancy/occupancy sensors. The standard covers all rooms in a home except closets under 70 square feet.

www.energy.ca.gov/title24

CSA

Canadian Standards Association

The Canadian Standards Association is a not-for-profit, membership-based association that conducts product safety testing, and issues certifications.

www.csa.org

GSA

General Services Administration Federal Supply Service

GSA's Federal Supply Service provides federal customers with a specific list of manufacturer's products that have been approved to meet stated requirements. The most frequently cited Federal Specifications regarding electrical wiring devices are those for Electrical Power Connector, Plug, Receptacle and Cable Outlet (Fed. Spec. W-C 596) and for Toggle and Lock, Flush Mounted Switches (Fed. Spec. W-S 896).

www.gsa.gov

NEC®

National Electrical Code®

Published by the NFPA (see listing) as NFPA 70, the National Electrical Code. This publication, renewed every 3 years under the auspices of ANSI, provides for the adequate protection of life and property from dangers associated with the use of electricity. It is now adopted and enforced in all 50 states in the United States and is also the basis for electrical codes in several other countries.

www.nfpa.org

NEMA

National Electrical Manufacturers Association

Comprised of electrical manufacturers, NEMA provides a forum for the standardization and testing of electrical equipment, enabling consumers to select from a range of safe, effective, and compatible electrical products. NEMA-standards of testing is frequently required by both government and third-party endorsees such as UL and CSA prior to their approval.

www.NEMA.org

NFPA

National Fire Protection Association

The mission of the international non-profit NFPA is to reduce the worldwide burden of fire and other hazards on the quality of life by providing and advocating scientifically based consensus codes and standards, research, training and education. The NFPA authors the NEC® and NPPA 70E electrical safety in the workplace.

www.nfpa.org

NOM

Normas Oficiales de México (Official Mexican Standards)

The Official Mexican Standards (referred to as Normas or NOMs) augment the Mexican Hazardous Materials Land Transportation Regulation and provide information relative to importing and exporting hazardous materials from and to Mexico.

OSHA

Occupational Health and Safety Administration, U.S. Department of Labor

OSHA's mission is to assure safe and healthful working conditions for working men and women (having been authorized to enforce standards first created under the Occupational Health and Safety Act of 1970 and since evolved), by assisting and encouraging the States in their efforts to assure safe and healthful working conditions.

www.osha.gov

UL

Underwriters Laboratories

Underwriters Laboratories Inc. (UL) is an independent, nonprofit product safety testing and certification organization.

www.ul.com

NSF

National Sanitation Foundation

NSF International helps protect people by certifying products and writing standards for consumer goods. As an independent, not-for-profit organization, NSF works toward allowing everyone to live safer.

www.nsf.org

Compliances, specifications and availability are subject to change without notice.

Organization acronyms

Standards development organizations

ANSI	American National Standards Institute
ASME	American Society of Mechanical Engineers
BRC	British Retail Consortium
CANENA	Consejo de Armonización de Normas Electrotécnicas de Norte América (Council for Harmonization of Electrotechnical Standardization of North America)
IEC	International Electrotechnical Commission
IEEE	Institute of Electrical and Electronics Engineers
ISA	Instrument Society of America
ISO	International Standards Organization
NFPA	National Fire Protection Agency
NSF	National Sanitation Foundation
SAE	Society of Automotive Engineers
SME	Society of Manufacturing Engineers
TITLE 24	California Building Energy Efficiency Standards

Certification agencies

ANCE	National Association of Normalization and Certification of the Electrical Sector (Mexico)
BSI	British Standards Institute
CCC	China Compulsory Certification
CE	European Compliance (This is not a certification agency, but CE is the European Compliance Mark)
CSA	Canadian Standards Association
cUL	Certified to CSA Standards by Underwriters Laboratories
cULus	Meets Canadian & US UL requirements
DESC	Defense Electronic Supply Center
ETL	Electrical Testing Laboratories
FCC	Federal Communications Commission
FM	Factory Mutual
IAPA	Independent Accident and Protection Association (Canada)
LEED	Leadership in Energy and Environmental Design
NRTL	National Recognized Testing Laboratories
OSHA	Occupational Safety and Health Administration
TUV	TUV Rheinland of N.A., Inc.
VDE	Verband Deutscher Elektrotechniker (Germany)

Certification agencies (continued)

UL	Underwriters Laboratories
	Wi-Fi Alliance - Wi-Fi Certification
	Z-Wave Alliance - Z-Wave Plus Certification

Codes & standards

CEC	Canadian Electrical Code
CEE	European Electrotechnical Committee
NEC	National Electrical Code®
NMX	Normas Mexicanas
NOM	Normas Oficiales de México (Official Mexican Standard)

Industry associations

ABYC	American Boat and Yacht Council
ASHE	American Society of Healthcare Engineering
ASHRAE	American Society of Heating Refrigerating and Air-Conditioning Engineers
BICSI	Building Industry Consulting Services International
BOMA	Building Owners Management Association
CANAME	Cámara Nacional de Manufacturas Eléctricas (México)
CEMRA	Canadian Electrical Manufacturers Representatives Association
ECOC	Electrical Contractors of Canada
EFI	Electro-Federation Incorporated
EIA	Electronics Industry Association
EPRI	Electric Power Research Institute
IAEI	International Association of Electrical Inspectors
IBI	Intelligent Building Institute
IECA	Independent Electrical Contractors Association
IFMA	International Facilities Management Association
NAED	National Association of Electrical Distributors
NAW	National Association of Wholesalers
NECA	National Electrical Contractors Association
NEMA	National Electrical Manufacturers Association
NEMRA	National Electrical Manufacturers Representative Association
NMDA	National Marine Distributor Association
NMRA	National Marine Representative Association
SEMI	Semi-Conductor Equipment and Material International
TIA	Telecommunications Industry Association
USGBC	US Green Building Council

Common UL & CSA standards for wiring devices

UL standards

UL20	General-use switches
UL50	Enclosures for electrical equipment
UL94	Flammability testing for materials, plastic
UL244A	Appliance controls
UL486E	Equipment and wiring terminals
UL496	Lampholders
UL498	Plugs, connectors, receptacles, inlets, outlets
UL498A	Taps and adapters
UL498B	Receptacles with integral switching means
UL508	Industrial equipment (including motor control switches)
UL514A	Metallic outlet boxes
UL514C	Nonmetallic outlet boxes and covers
UL514D	Wallplates for flush mounted wiring devices
UL746C	Polymeric materials for use in electrical equipment
UL817	Cord sets
UL943	GFCIs
UL1310	Class 2 Power Units
UL1363	Relocatable power taps
UL1436	Outlet circuit testers
UL1449	Surge suppression devices
UL1472	Dimmers
UL1567	Switches and receptacles used with AL wire

UL standards (continued)

UL1698	LED Luminaires
UL1699	Arc fault circuit interrupters
UL1786	Plug-In nightlights
UL1863	Communications circuit accessories
UL1917	Solid state fan speed control

Standards

IEC 60309-1/2	Plugs, socket-outlets and couplers for industrial purposes
SSL 7A	NEMA phase cut dimming for solid state lighting compatibility
W-C-596	Federal Specification electrical plugs, receptacles and cable outlets
WD-1	NEMA General color requirements for wiring devices
WD-6	NEMA Wiring devices dimensional specifications
W-S-896	Federal Specification switches

CSA standards

C22.2 No. 0.17	Polymeric materials
C22.2 No. 12	Night lights
C22.2 No. 42	General-use receptacles, attachment plugs
C22.2 No. 111	General-use switches
C22.2 No. 144	GFCI
C22.2 No. 182.1	Industrial-type, special-use attachment plugs, receptacles and connectors. Pin and sleeve devices
C22.2 No. 182.2	Industrial locking type, special-use attachment plugs, receptacles and connectors

Compliances, specifications and availability are subject to change without notice.

Selected articles, National Electric Code (NEC®) requirements for wiring devices from NFPA 70™, NEC® 2020 Edition

Article 210 — Branch circuits

210.8	Ground-fault circuit-interrupter protection for personnel
210.12	Arc-fault circuit-interrupter protection
210.21	Branch circuit ratings, outlet devices
210.24	Branch circuit requirements - summary
210.50	Required outlets, general
210.60	Required outlets, guest rooms, guest suites, dormitories and similar occupancies
210.62	Required outlets, show windows
210.70	Lighting outlets required

Article 404 — Switches

404.2	Installation, switch connections
404.3	Installation, enclosure
404.4	Installation, damp or wet locations
404.9	Installation, provisions for general-use snap switches
404.14	Rating and use of snap switches
404.20	Construction specifications, marking

Article 406 — Receptacles, cord connectors & attachment plugs (caps)

406.3	Receptacle rating and type
406.4	General installation requirements
406.5	Receptacle mounting
406.6	Receptacle faceplates (cover plates)
406.7	Attachment plugs, cord connectors and flanged surface devices
406.8	Noninterchangeability
406.9	Receptacles in damp or wet locations
406.10	Grounding-type receptacles, adapters, cord connectors and attachment plugs
406.12	Tamper-resistant receptacles

Article 430 — Motors, motor circuits & controllers

430.8	Marking on controllers
430.81	Motor controllers, general
430.82	Motor controllers, controller design
430.83	Motor controllers, ratings
430.90	Combination fuseholder and switch as controller
430.102	Disconnecting means, location
430.109	Disconnecting means, type

Article 517 — Health care facilities

517.2	Definitions
517.10	Wiring and protection, applicability
517.13	Grounding of receptacles and fixed electrical equipment in patient care areas
517.14	Panelboard bonding
517.16	Use of isolated ground receptacles
517.17	Ground-fault protection
517.18	Wiring and protection, general care areas
517.19	Wiring and protection, critical care areas
517.20	Wiring and protection, wet procedure locations
517.21	Ground-Fault-Circuit-Interrupter protection for personnel
517.29	Essential electrical systems for hospitals
517.32	Branches requiring automatic connection
517.41	Required power sources
517.42	Essential electrical systems for nursing homes and limited care facilities
517.45	Essential electrical systems for other health care facilities
517.61	Inhalation anesthetizing locations, wiring and equipment
517.62	Inhalation anesthetizing locations, grounding
517.63	Grounded power systems in anesthetizing locations
517.64	Inhalation anesthetizing locations, low-voltage equipment and instruments
517.71	X-ray installations connection to supply circuit
517.72	X-ray installations disconnecting means
517.160	Isolated power systems

Article 555 — Marinas, boatyards, floating buildings, & commercial and noncommercial docking facilities

555.1	Scope
555.33	Receptacles
555.34	Wiring methods and installations
555.35	Ground-Fault Protection of Equipment (GFPE) and Ground-Fault Circuit-Interrupter (GFCI) Protection
555.36	Disconnecting means for shore power connection(s)
555.56	Equipment grounding

Article 590 — Temporary installations

590.4	General
590.6	Ground-fault protection for personnel

Article 604 — Manufactured wiring systems

604.2	Definition
604.100	Construction

Article 630 — Electric welders

630.13	Arc welders, disconnecting means
630.33	Resistance welders, disconnecting means

Article 647 — Sensitive electronic equipment

647.7	Receptacles (including isolated ground receptacles)
-------	---

Article 660 — X-ray equipment

660.4	Connection to supply circuit
660.5	Disconnecting means

Article 700 — Emergency systems

700.31	Overcurrent protection, ground-fault protection of equipment
--------	--

Compliances, specifications and availability are subject to change without notice.

Wire & cable type abbreviations

Key

E	Thermoplastic elastomer	S	Extra hard usage (600V)	V	Vacuum (typically used for portable cleaning equipment)
O	Oil resistant outer jacket	SJ	Junior hard usage (300V)	W	Weather & water resistant for damp & wet locations
OO	Oil resistant outer jacket & oil resistant insulation	T	Thermoplastic/vinyl		
P	Parallel				

Examples

SE00W	Extra hard usage thermoplastic elastomer with oil resistant outer jacket and insulation; approved for outdoor use and water resistance; 600V up to 105°C.	SPT-2	Same as SPT-1, but heavier construction (18-16 gauge).
SJT	Hard usage thermoplastic rubber-insulated conductors and overall thermoplastic jacket. 300V up to 105°C.	SPT-3	Same as SPT-2, but heavier construction (18-10 gauge).
SJTW	Hard usage thermoplastic or rubber-insulated conductors and overall thermoplastic jacket. 300V up to 105°C. Weather resistant for outdoor use.	SRDT	Portable range or dryer cable, 3-conductor parallel type or 4 insulated conductors, jacketed. All thermoplastic construction. 300V, maximum temperature of 60°C.
SPT-1	All thermoplastic construction, parallel jacketed. 300V up to 105°C, 2 or 3-conductor (18 gauge).	HPN	Two-conductor, neoprene-insulated heater cord. Parallel construction. For use in damp locations. 300V, 90°C.

Diameter ranges of jacketed cord in accordance with standard UL62

Acceptable range for overall diameter of jacketed cord

Type of cord	Avg. size	2-Conductor	3-Conductor	4-Conductor	5-Conductor
SV, SVO, SVT SVTO	18	0.22"-0.26" (5.6mm-6.6mm)	0.23"-0.27" (5.8mm-6.9mm)	—	—
SJ, SJE, SJO, SJOO, SJEO, SJEOO, SJT, SJTO, SJTOO, SJEW, SJEOW, SJEOOW, SJTW, SJTOW, SJTOOW	18	0.28"-0.32" (7.1mm-8.1mm)	0.30"-0.34" (7.6mm-8.6mm)	0.33"-0.37" (8.4mm-9.4mm)	—
	16	0.31"-0.34" (7.9mm-8.6mm)	0.33"-0.36" (8.4mm-9.1mm)	0.35"-0.40" (8.9mm-10.2mm)	—
	14	0.34"-0.38" (8.6mm-9.7mm)	0.36"-0.40" (9.1mm-10.2mm)	0.39"-0.44" (9.9mm-11.2mm)	—
	12	0.41"-0.46" (10.4mm-11.7mm)	0.43"-0.48" (10.9mm-12.2mm)	0.47"-0.52" (11.9mm-13.2mm)	—
	10	0.54"-0.61" (13.7mm-15.5mm)	0.57"-0.64" (14.5mm-16.3mm)	0.63"-0.70" (16.0mm-17.8mm)	—
S, SE, SOO, SEO, SEOO, ST, STOO, STO, SEW, SOOW, SOW, SEOW, SEOWW, STW, STOOW, STOW	18	0.34"-0.39" (8.6mm-9.9mm)	0.36"-0.40" (9.1mm-10.2mm)	0.39"-0.43" (9.9mm-10.9mm)	0.46"-0.51" (11.7mm-13.0mm)
	16	0.37"-0.41" (9.4mm-10.4mm)	0.39"-0.43" (9.9mm-10.9mm)	0.41"-0.46" (10.4mm-11.7mm)	0.49"-0.55" (12.4mm-14.0mm)
	14	0.50"-0.55" (12.7mm-14.0mm)	0.52"-0.58" (13.2mm-14.7mm)	0.56"-0.62" (14.2mm-15.7mm)	0.63"-0.71" (16.0mm-18.0mm)
	12	0.57"-0.63" (14.5mm-16.0mm)	0.59"-0.66" (15.0mm-16.8mm)	0.64"-0.71" (16.3mm-18.0mm)	0.70"-0.77" (17.8mm-19.6mm)
	10	0.62"-0.69" (15.7mm-17.5mm)	0.65"-0.72" (16.5mm-18.3mm)	0.70"-0.78" (17.8mm-19.8mm)	0.76"-0.84" (19.3mm-21.3mm)
	8	0.78"-0.88" (19.8mm-22.4mm)	0.83"-0.93" (21.1mm-23.6mm)	0.93"-1.05" (23.6mm-26.7mm)	1.00"-1.15" (25.4mm-29.2mm)
	6	0.92"-1.05" (23.4mm-26.7mm)	0.97"-1.10" (24.6mm-27.9mm)	1.05"-1.20" (26.7mm-30.5mm)	1.18"-1.33" (30.0mm-33.8mm)
	4	1.06"-1.21" (26.9mm-30.7mm)	1.13"-1.28" (28.7mm-32.5mm)	1.25"-1.45" (31.8mm-38.1mm)	—
2	1.21"-1.40" (30.7mm-35.6mm)	1.30"-1.50" (33.0mm-38.1mm)	1.45"-1.65" (36.8mm-41.9mm)	—	

Compliances, specifications and availability are subject to change without notice.

2-pole, 2-wire non-grounding: 125V

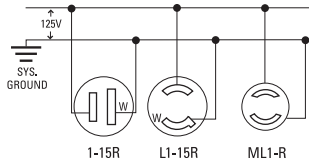

2-pole, 2-wire non-grounding: 250V

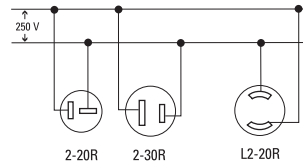

2-pole, 3-wire grounding: 125V

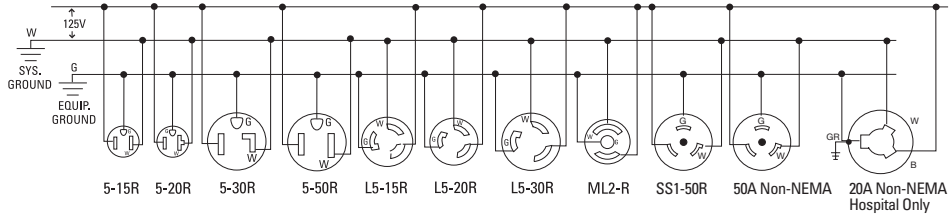

2-pole, 3-wire grounding: 250V/AC

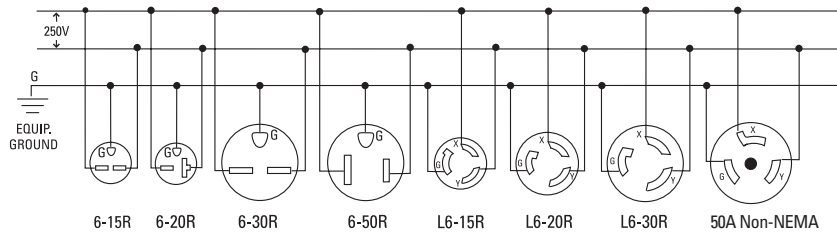

2-pole, 3-wire grounding: 240V

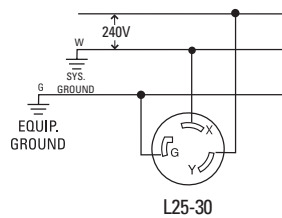

2-pole, 3-wire grounding: 277V AC

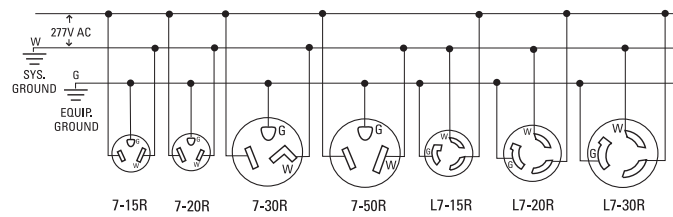

2-pole, 3-wire grounding: 480V/AC

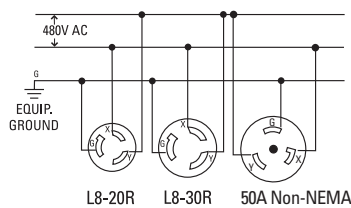

2-pole, 3-wire grounding: 600V/AC, 250V/DC

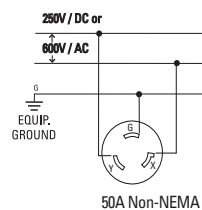

2-pole, 3-wire grounding: 600V/AC

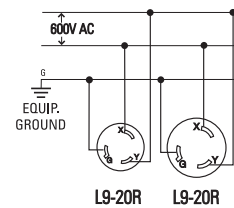

Compliances, specifications and availability are subject to change without notice.

3-pole, 3-wire non-grounding: 125/250V

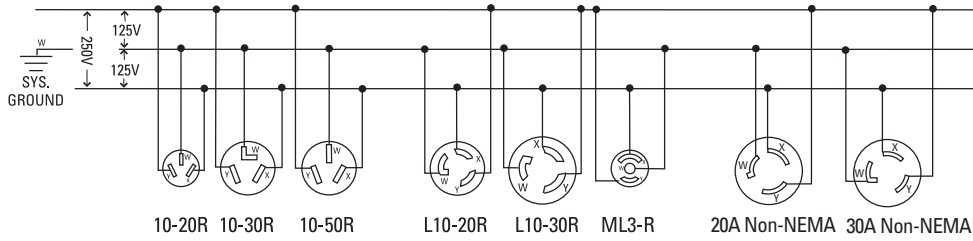

3-pole, 3-wire non-grounding: 3Ø 250V

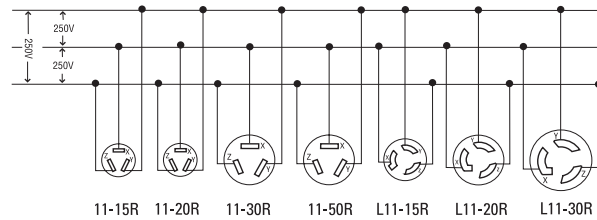

3-pole, 4-wire grounding: 125/250V

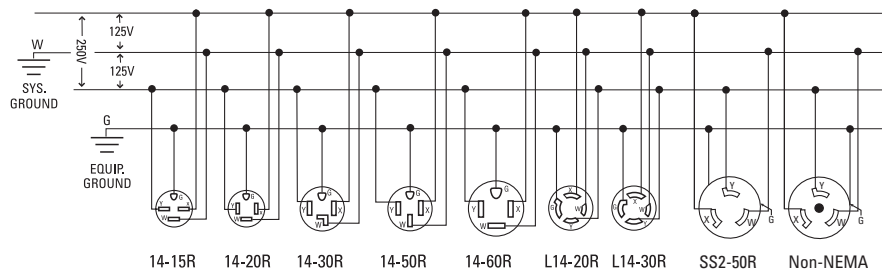

3-pole, 3-wire non-grounding: 3Ø 480V AC

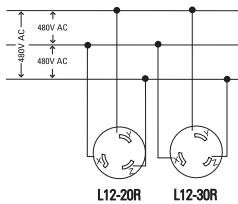

3-pole, 3-wire non-grounding: 3Ø 600V AC

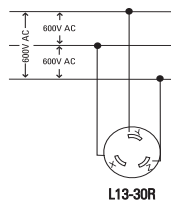

3-pole, 4-wire grounding: 3Ø 250V

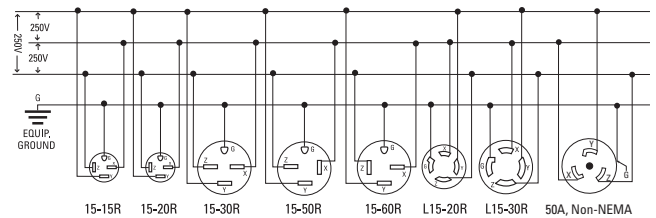

3-pole, 4-wire grounding: 3Ø 480V

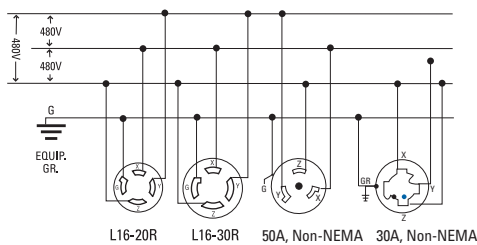

3-pole, 4-wire grounding: 3Ø 600V

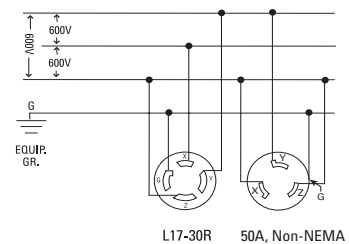

Compliances, specifications and availability are subject to change without notice.

4-pole, 4-wire non-grounding: 3Ø 120/208V

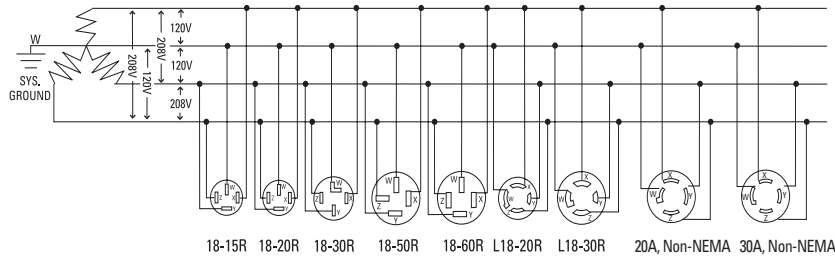

4-pole, 4-wire non-grounding: 3Ø 277/480V

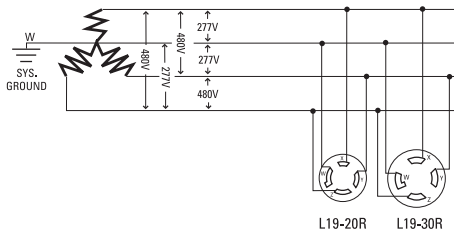

4-pole, 4-wire non-grounding: 3Ø 347/600V

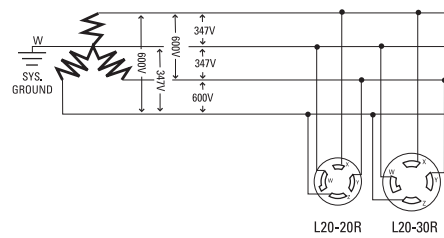

4-pole, 5-wire grounding: 3Ø 120/208V

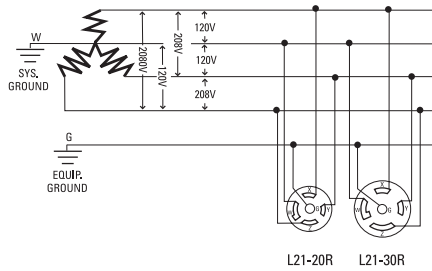

4-pole, 5-wire grounding: 3Ø 240/415V

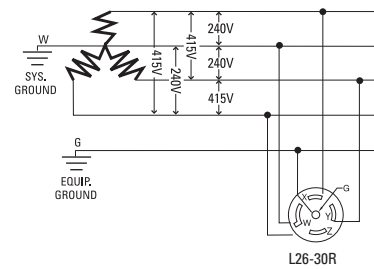

4-pole, 5-wire grounding: 3Ø 277/480V

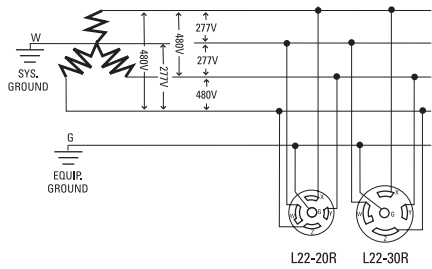

4-pole, 5-wire grounding: 3Ø 347/600V

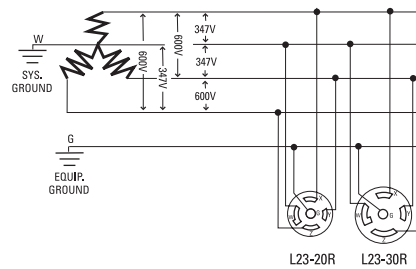

Compliances, specifications and availability are subject to change without notice.

Wiring diagrams (by NEMA configurations)

Receptacles wiring diagrams

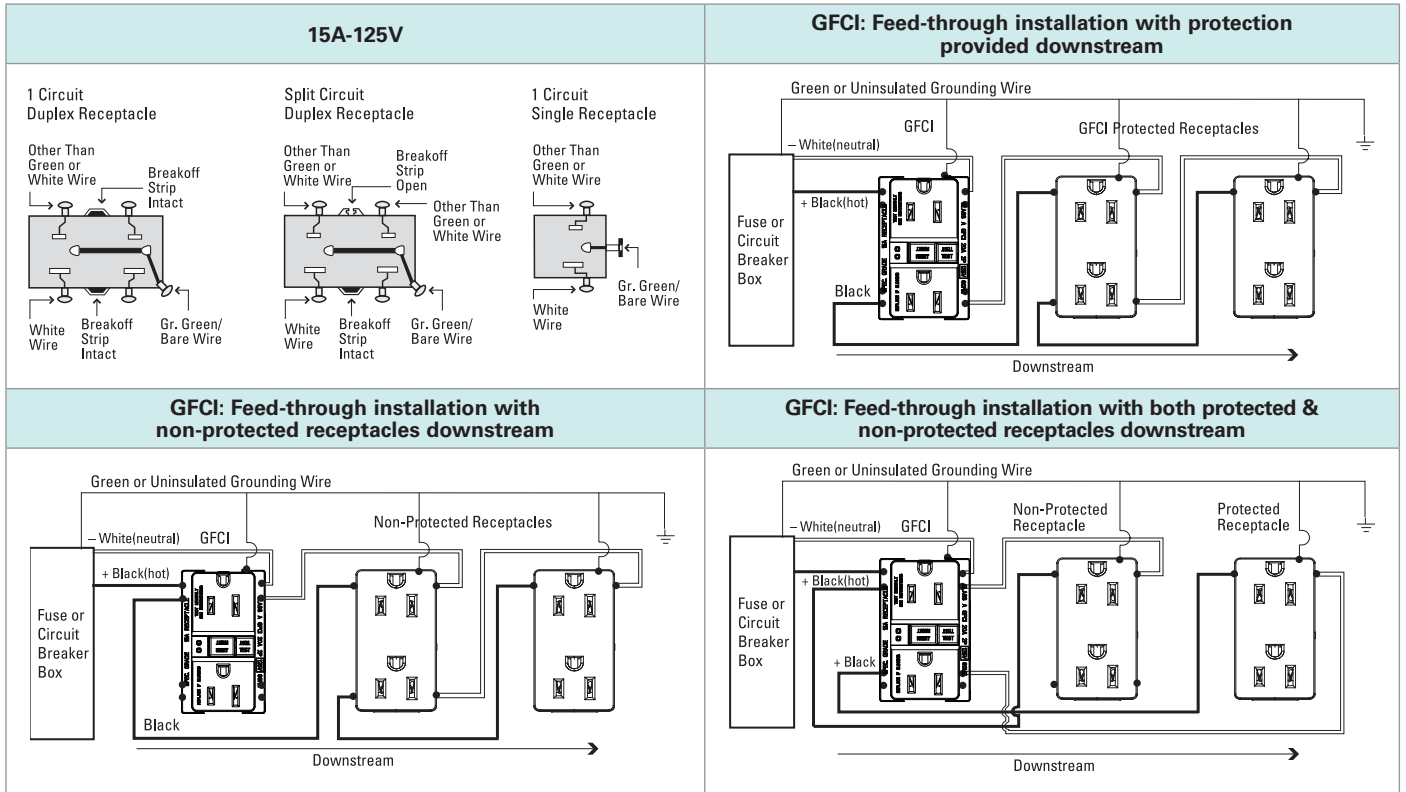

Combination devices wiring diagrams

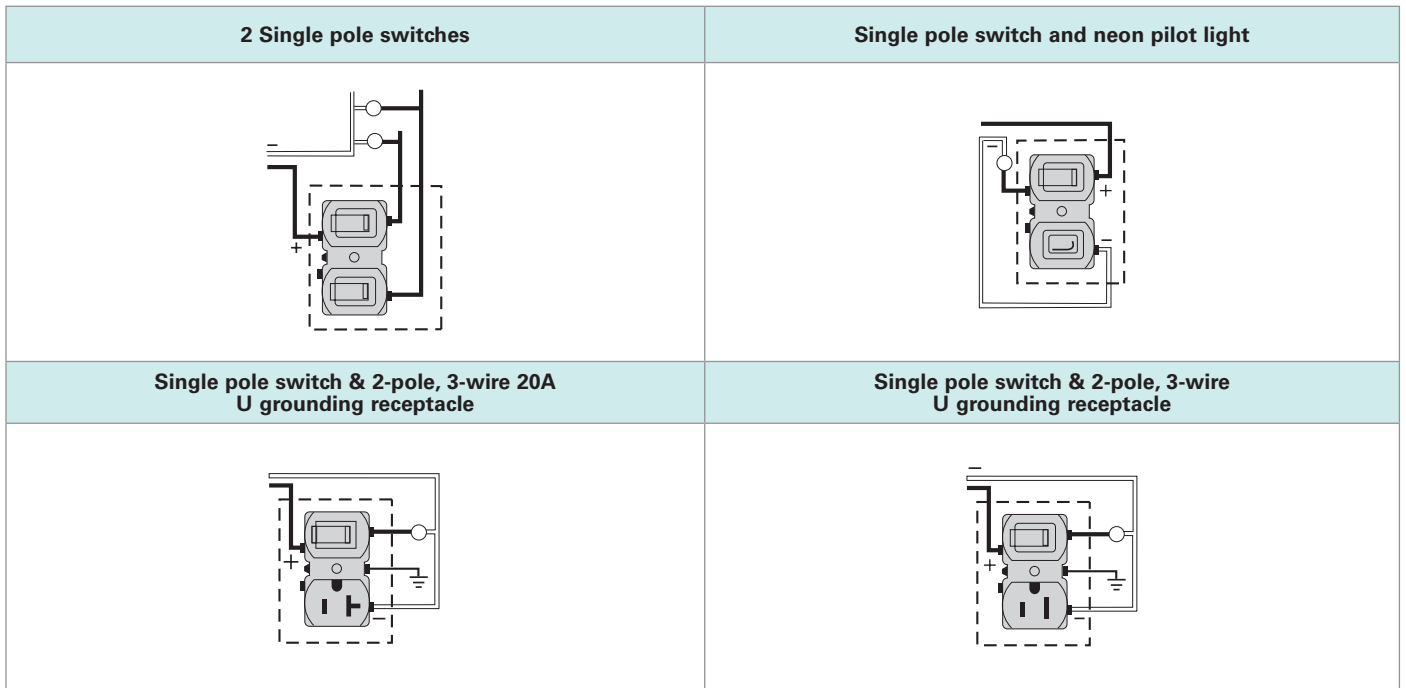

Compliances, specifications and availability are subject to change without notice.

Switches wiring diagrams

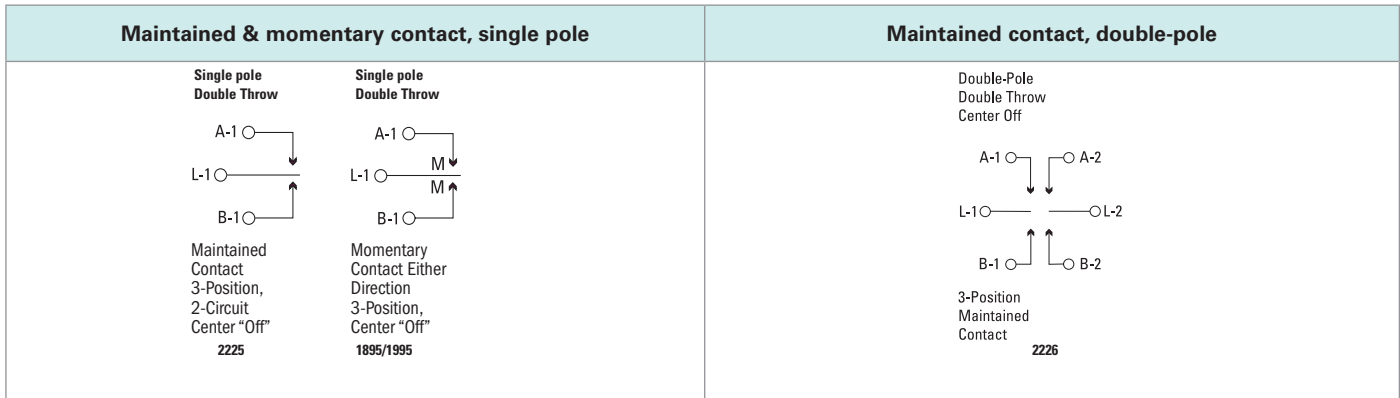

Manual contactors & disconnect switches

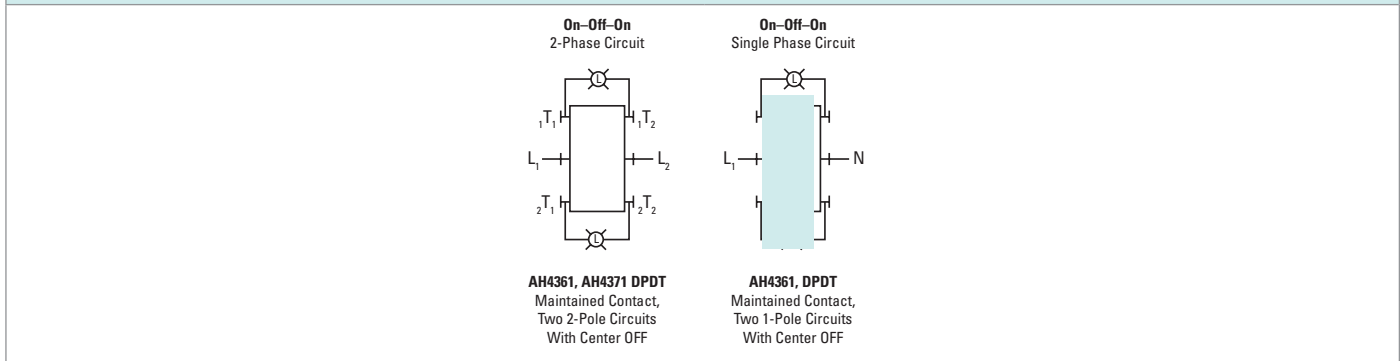

AC switches

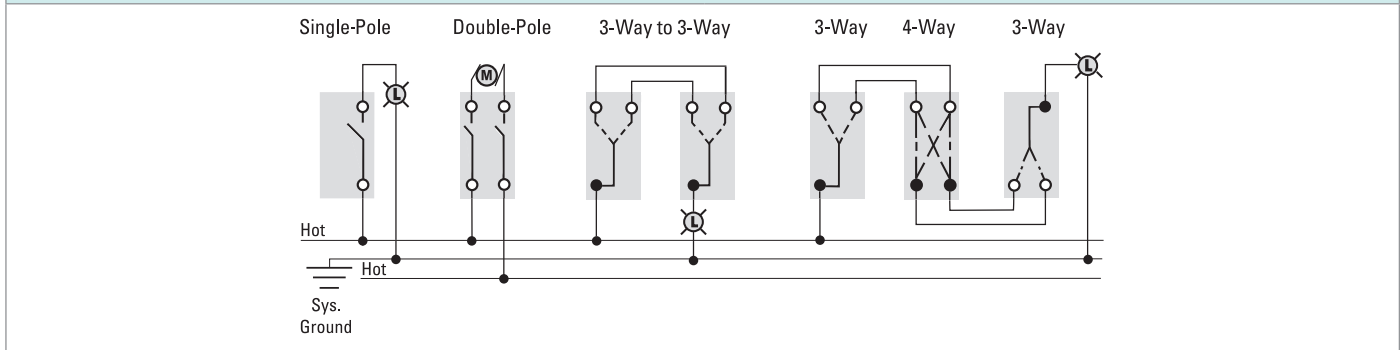

Pilot light switch & lighted switch, single & double pole	Pilot light switch & lighted switch, 3-Way
---	--

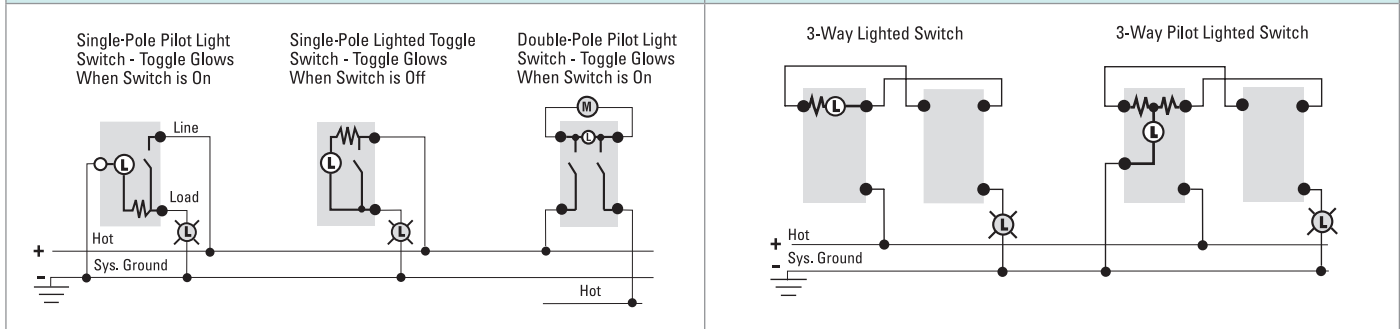

Compliances, specifications and availability are subject to change without notice.

Wiring diagrams (dimmers)

Wi-Fi smart universal dimmer

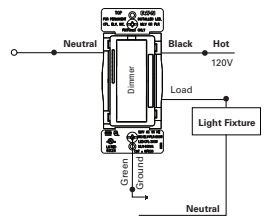
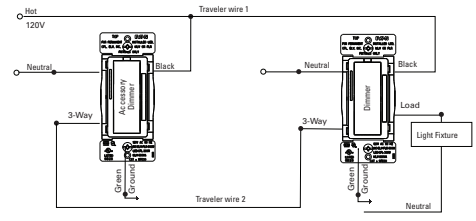
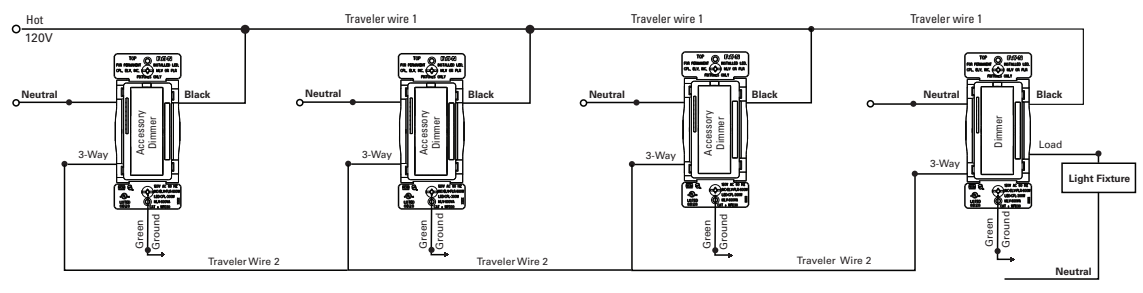
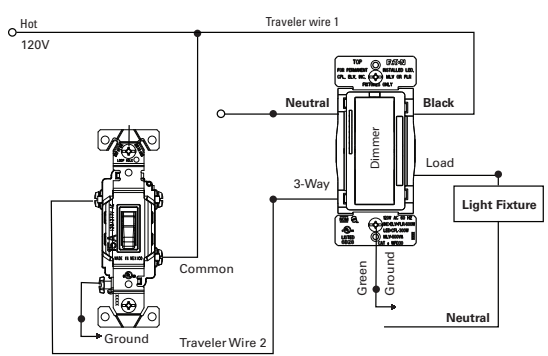
<p>WFD30</p> <p>LED/CFL/INC/MLV/ELV/HAL/FLR Single location requires one dimmer</p> 	<p>WFD30</p> <p>LED/CFL/INC/MLV/ELV/HAL/FLR Two location requires one Wi-Fi dimmer and one accessory dimmer</p> 
<p>WFD30</p> <p>LED/CFL/INC/MLV/ELV/HAL/FLR Multiple locations using several accessory dimmers</p> 	
<p>WFD30</p> <p>LED/CFL/INC/MLV/ELV/HAL/FLR Two location control using dimmer and 3-Way switch</p> 	

Compliances, specifications and availability are subject to change without notice.

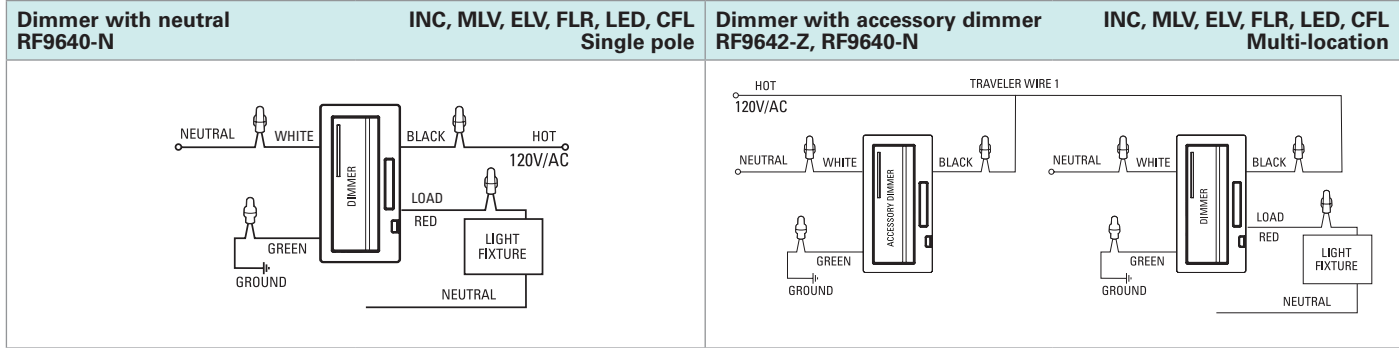

Aspire, Electronic

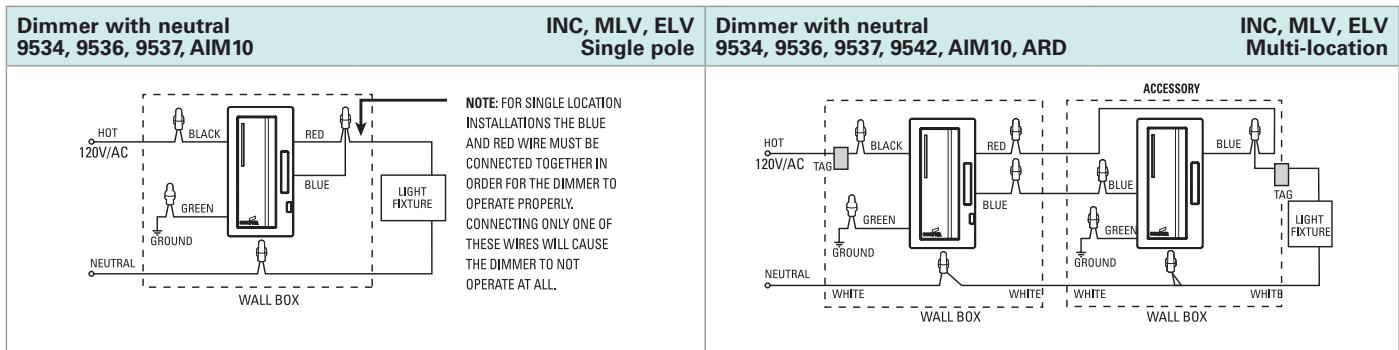

Electronic

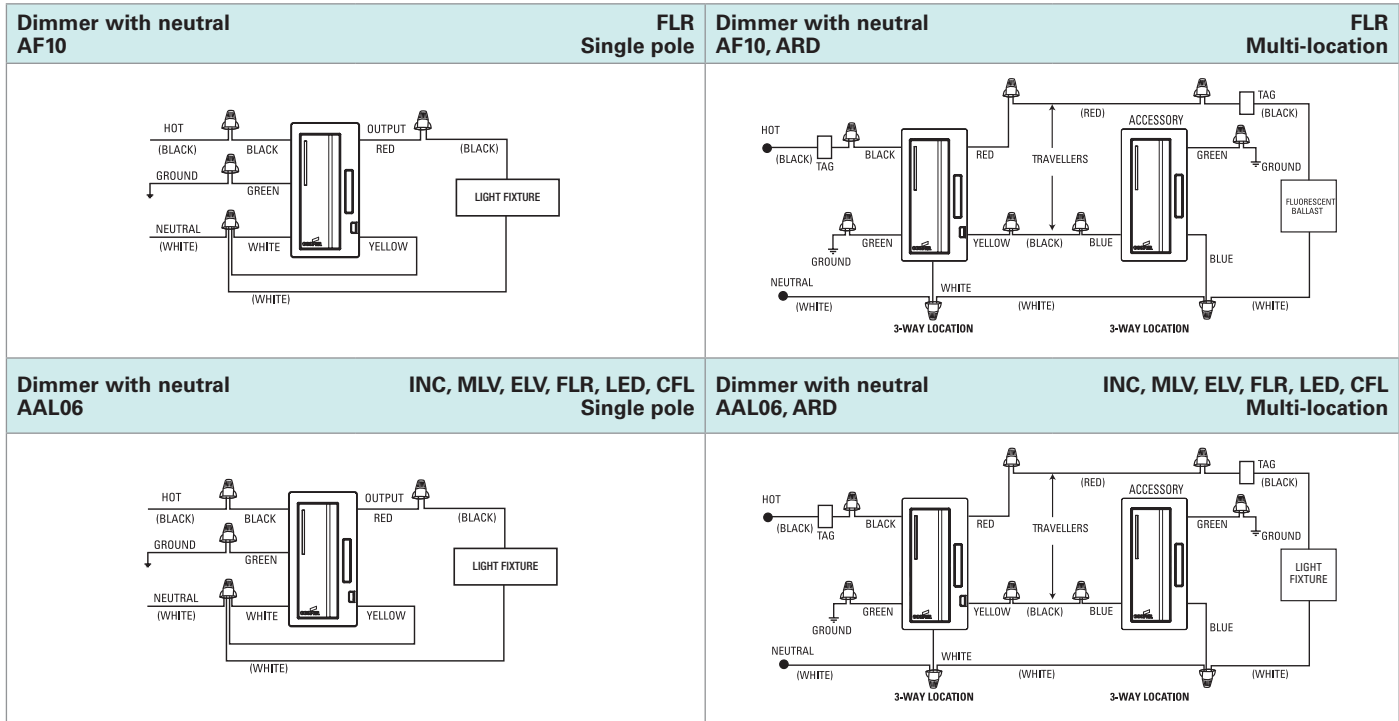

Compliances, specifications and availability are subject to change without notice.

Wiring & coverage diagrams

Dimmers

<p>Decorator & Slide dimmer DUL06P, SUL06P</p>	<p>Decorator & Slide dimmer DUL06P, SUL06P</p>
<p>INC, MLV, ELV, FLR, LED, CFL Single pole</p>	<p>INC, MLV, ELV, FLR, LED, CFL 3-Way</p>
<p>Aspire Slide dimmers 9530, 9531, 9532, 9533</p>	<p>Aspire Slide dimmers 9530, 9531, 9532, 9533</p>
<p>INC, MLV, ELV Single pole</p>	<p>INC, MLV, ELV 3-Way</p>
<p>Decorator, Slide dimmers 9568, 95687, DF8AP, DF8AP7, SF8AP7</p>	<p>Decorator, Slide dimmers 9568, 95687, DF8AP, DF8AP7, SF8AP7</p>
<p>FLR Single pole</p>	<p>FLR 3-Way</p>
<p>Slide dimmer 9573</p>	<p>Slide dimmer 9573</p>
<p>LED, CFL, INC Single pole</p>	<p>LED, CFL, INC 3-Way</p>

Compliances, specifications and availability are subject to change without notice.

<p>Aspire slide dimmer/fan control 9544, 9543</p>	<p>3-Speed & fully variable Single pole</p>	<p>Aspire slide dimmer/fan control 9544, 9543</p>	<p>3-Speed & fully variable 3-Way</p>
<p>Decorator dimmer/fan control DI10P, DFS15P1</p>	<p>INC, MLV Single pole</p>	<p>Decorator dimmer/fan control DI10P, DFS15P1</p>	<p>INC, MLV 3-Way</p>
<p>Slide dimmer/fan control SI061, SI10P, SFS15P, SFS5P, SFS5</p>	<p>INC, MLV Single pole</p>	<p>Slide dimmer/fan control SI061, SI10P, SFS15P, SFS5P, SFS5</p>	<p>INC, MLV 3-Way</p>
<p>Slide dimmer/fan control SDC15</p>	<p>3-Speed, INC Single pole</p>	<p>Toggle/rotary fan control TFS5, RFS5, RFS15</p>	<p>Fully variable Single pole</p>

Compliances, specifications and availability are subject to change without notice.

Wiring & coverage diagrams

Dimmers & fan speed controls

<p>Toggle dimmer TUL06P INC, MLV, ELV, FLR, LED, CFL Single pole</p>	<p>Toggle dimmer TUL06P INC, MLV, ELV, FLR, LED, CFL 3-Way</p>
<p>Toggle dimmers TI061, TI061L, TI3101, TI3101L INC Single pole</p>	<p>Toggle dimmer TI061, TI061L, TI3101, TI3101L INC 3-Way</p>
<p>Rotary dimmer RI061, RI101, RI06P, RI06PL INC Single pole</p>	<p>Rotary dimmer RI06P, RI06PL INC 3-Way</p>
<p>Rotary fan/dimmer RDC15, RDC25 4-Speed/INC & fully variable/INC Single pole</p>	<p>Humidity Sensor and Fan Control HDFS3P1 INC</p>

Compliances, specifications and availability are subject to change without notice.

<p>Universal sensor dimmer OSUL06D, VSUL06D</p> <p>INC, MLV, ELV, FLR, LED, CFL Single pole</p>	<p>Universal sensor dimmer OSUL06D, VSUL06D</p> <p>INC, MLV, ELV, FLR, LED, CFL 3-Way</p>
<p>Sensor switch OS310U, VS310U</p> <p>All load types Single pole</p>	<p>Sensor switch OS310U, VS310U</p> <p>All load types 3-Way</p>
<p>Standard sensor OS306U, VS306U</p> <p>INC, MLV, ELV, FLR, LED, CFL Single pole</p> <p>DIAGRAM 1: SENSOR IN ONE LOCATION</p>	<p>Standard sensor OS306U, VS306U</p> <p>INC, MLV, ELV, FLR, LED, CFL 3-Way with sensor in location with hot wire</p>
<p>Standard sensor OS306U, VS306U</p> <p>INC, MLV, ELV, FLR, LED, CFL 3-Way with switch in location with hot wire</p>	

Compliances, specifications and availability are subject to change without notice.

Wiring & coverage diagrams

Occupancy & vacancy sensor coverage areas

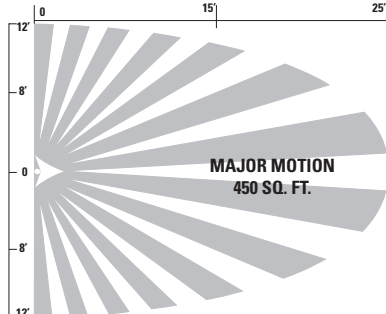
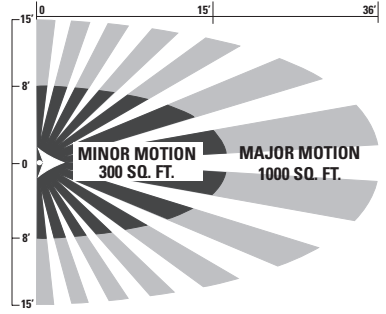
Standard series OS306U, VS306U	Sensor switch OS310U, VS310U, OS310R, VS310R, OSUL06D, VSUL06D
<p style="text-align: center;">All load types</p> 	<p style="text-align: center;">All load types</p> 

Timers

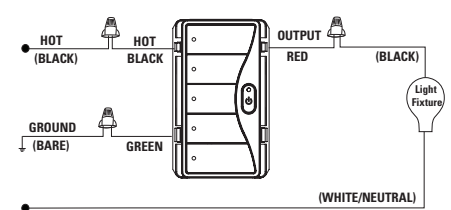
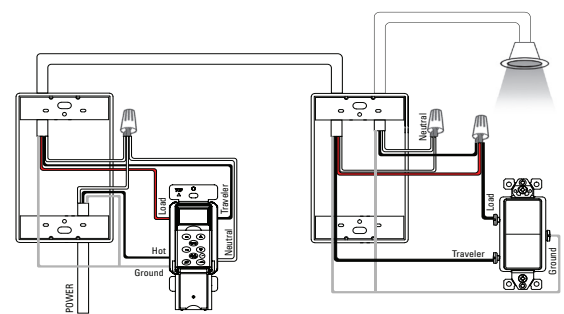
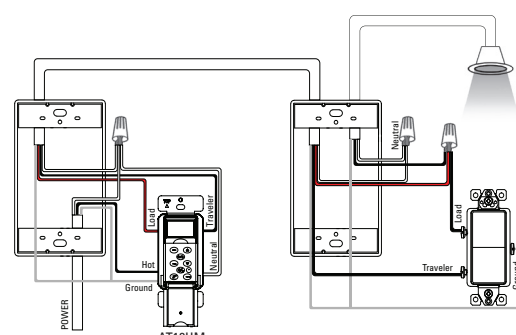
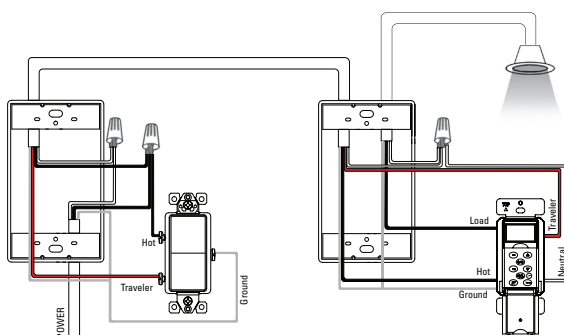
Aspire, electronic timer 9590, 9591, PT18M, PT18H	Astronomic Programmable Timer AT18HM
<p style="text-align: center;">INC, MLV, ELV, FLR, LED, CFL Single pole</p> 	<p style="text-align: center;">INC, LED, CFL Single pole</p> 
<p style="text-align: center;">Astronomic Programmable Timer AT18HM (Power to 3-Way switch)</p> <p style="text-align: center;">INC, LED, CFL 3-Way</p> 	<p style="text-align: center;">Astronomic Programmable Timer AT18HM (Power to the timer)</p> <p style="text-align: center;">INC, LED, CFL 3-Way</p> 

Compliances, specifications and availability are subject to change without notice.

Diagram 1
Capacitor Two Windings

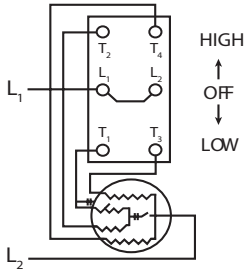

Diagram 2
Repulsion Induction

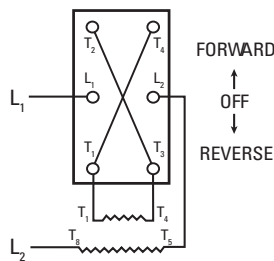

Diagram 3
Series

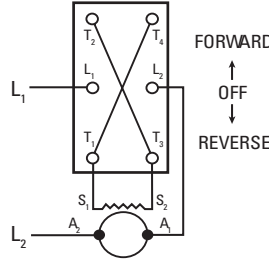

Diagram 4
Capacitor Consequence Pole

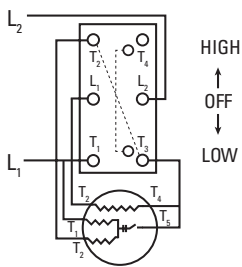

Diagram 4
Internal Connections

LOW	L ₁ & T ₂	L ₂ & T ₃
HIGH	L ₁ & T ₁	L ₂ to T ₂ & T ₃

Diagram 5
Capacitor

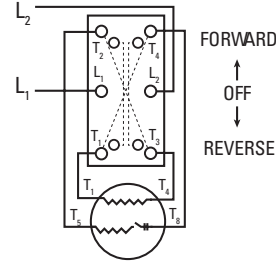

Diagram 5 & 6
Internal Connections

	L ₁	L ₂
FORWARD	T ₁ & T ₂	T ₃ & T ₄
REVERSE	T ₁ & T ₄	T ₃ & T ₂

Diagram 6
Split Phase

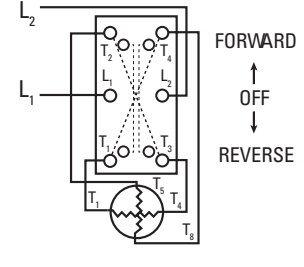

Diagram 7
3-Phase Separate Winding

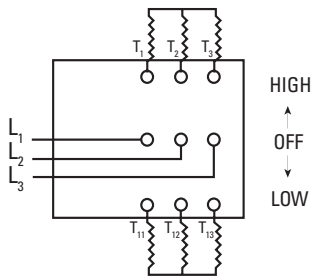

Diagram 8
3-Phase Induction

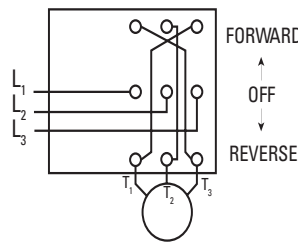

Diagram 9
Series DC

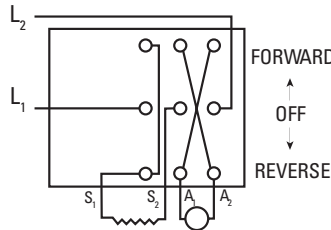

Diagram 10
Shunt DC

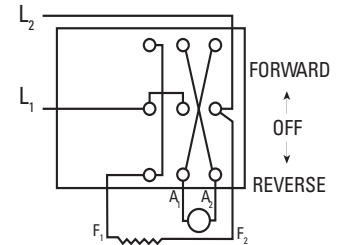

Diagram 11
Compound DC

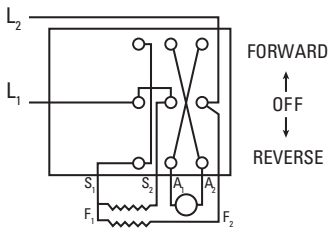

Diagram 12
2-Phase Separate Winding

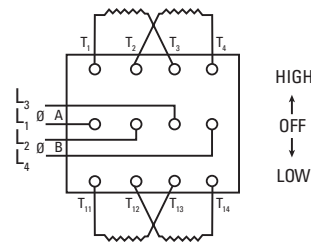
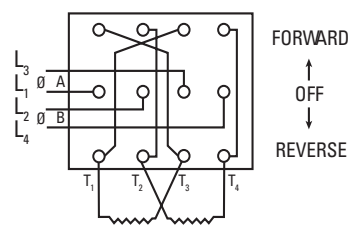
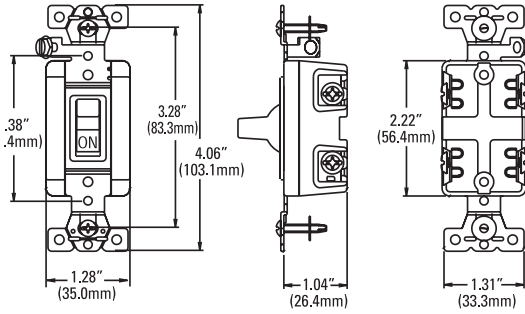

Diagram 13
2-Phase Induction



Compliances, specifications and availability are subject to change without notice.

AH6808UDAC, AH6808UCO



AH6810U, AH7810UD

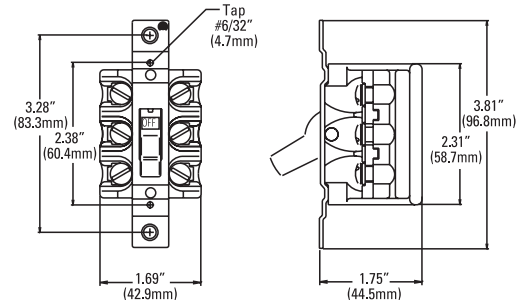

AHMC240L, AHMC340L, AHMC260L, AHMC360L

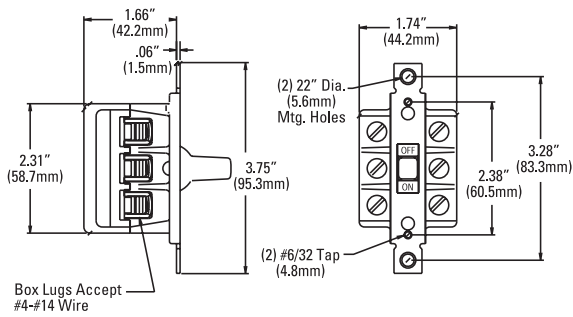

AHMC240C, AHMC340C

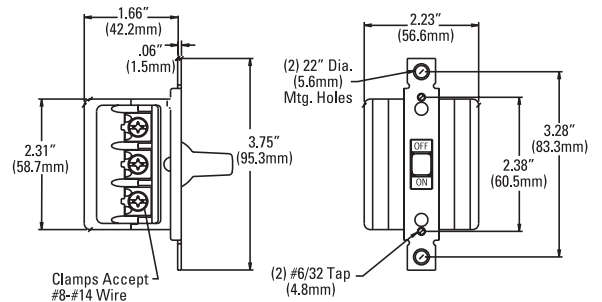

AH4361

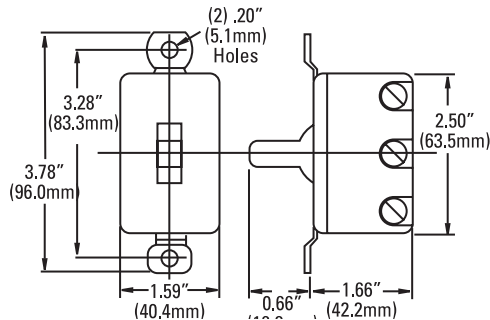

Compliances, specifications and availability are subject to change without notice.

<p>AH6810E, AH7810ED</p>	<p>AHMC360L-1, AHMC260L-1, AH7810GD, AHMC340C-1, AHAHMC340L-1, AH6808GDAC, AH6810G, AHMC240C-1, AHMC240L-1, AH27940G, AHN1GD</p>	
<p>AH6808WDAC</p>	<p>AH7810GDB, AHN1GD2 Dim A=2.63" (66.80mm)</p>	<p>AHN1GD2D Dim A=3.87" (98.30mm)</p>
<p>AHN3WD, AH6808WDAC, AH6810W, AHMC240C-3, AHMC240L-2, AHMC260L-3, AHMC340C-3, AHMC340L-2, AHMC360L-2</p>	<p>AH6808FDAC (plate only, no toggle guard) AH7810FD</p>	
<p>AHDS30, AHDS30AC, AHDS30VFD</p>	<p>AHDS60, AHDS60AC, AHDS60VFD</p>	
<p>AHDS30SSR</p>	<p>AHDS60SSR, AHDS100SSR</p>	

Compliances, specifications and availability are subject to change without notice.

Matching the dimmer to the load

A large selection of lighting sources are available in today's lighting environment. These sources have specific individual characteristics which require mating a particular dimmer for each load type (source). For proper use it is important to pick a dimmer that is designed and UL tested for that specific lighting load type.



Incandescent/halogen

Line-voltage tungsten filament lamps, including line-voltage (120V) halogen lamps
Electrical characteristic: resistive
Special requirements: rated for cold filament inrush.



Magnetic Low-Voltage (MLV)

Magnetic transformer-supplied low-voltage lighting (6 volt, 12 volt, or 24 volt)
Electrical characteristic: inductive
Special requirements: symmetric cycles ($VDC \leq 2$), smooth turn off
Include transformer losses when calculating the load.



Electronic Low-Voltage (ELV)

Electronic (solid-state) transformer-supplied low-voltage lighting
Electrical characteristic: capacitive
Special characteristic: very smooth turn on.
Neutral wire connection required.



Fluorescent (FLR)

Electronic fluorescent dimming ballast
Special dimmers are designed and UL listed to send power and control signals to each type of electronic fluorescent dimming ballast.



Light Emitting Diode (LED)

Electronic LED driver special dimmers are designed to send power and control signals to each type of electronic LED drive.
Special requirements: LED light source must be properly matched to LED driver, and LED driver must meet control spec for control type.



Fan controls

There are two styles of fan control. Select the one that is right for your application:

Fully variable

- Fully variable fan speed
- Used for controlling one or more ceiling fan(s) or exhaust fan(s)

Quiet 3-Speed

- Three speeds plus off
- Will not cause fan motor hum
- Used for controlling one ceiling fan only

Magnetic low-voltage dimmer ratings

The stated VA (volt-ampere) rating is the rated capacity of the dimmer which includes the magnetic transformer heat losses and the lamp load. A slide dimmer that is UL listed for 1000VA can be loaded with a full 1000VA of lamp load. A transformer dissipates up to 20% of the connected load as heat. Better transformers dissipate less than 10% as heat. Added together, the lamp load and the transformer loss determine the dimmer capacity required. See example.

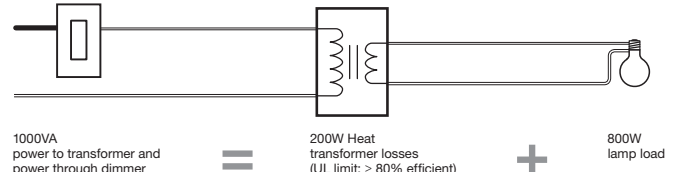

Electronic low-voltage dimmer ratings

Electronic Low-Voltage transformers do dissipate some heat. These inefficiencies are small enough to be accounted for in the dimmer rating. A dimmer this is UL listed for 600W can be loaded with a full 600W of lamp load. If ganged with other dimmers, standard derating rules apply.

Heat dissipation

During normal operation, dimmers will get warm to the touch. Wallbox dimmer efficiency is typically around 99%; the remaining 1% is dissipated as heat. Therefore, a 600W load on a 600W dimmer would produce around 6 watts of heat. Operating on its rated load, dimmers will stay below the UL limits of 140°F(60° C). Use screwless wallplates to avoid contact with metal screws that may feel warm to the touch.

Single pole



Single pole dimmers provide control from one location.

Multi-location



Multi-location dimmers can be used with dimmers for full dimming control of the lights from two or more locations.

3-Way/4-Way

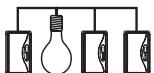

3-Way dimmers adjust the light level from one location. When used with 3-Way and 4-way switches, the lights can be turned on to the dimmer level or off from many locations.

Consult with Eaton's Wiring Devices for driver compatibility: www.eaton.com/wiringdevices

Fluorescent lampholder panel cutout dimensional data

Panel cutouts 2500, 2501, 2503, 2504	2505, 2506	Panel cutouts 2509, 2510	924
<p>1.343" (34.11mm) 1.130" (28.70mm) 0.1875" (4.76mm) Diam. Hole or Wide Slot</p>	<p>1.130" (28.70mm) 1.130" (28.70mm) Slide-on Slot for 20 Gauge Panel</p>	<p>0.188" (4.77mm) 1.016" (25.81mm) 0.156" (3.96mm) Diam. Hole or Wide Slot 0.344" (8.74mm)</p>	<p>0.188" (4.77mm) 1.016" (25.81mm) 0.156" (3.96mm) Diam. Hole or Wide Slot 0.344" (8.74mm) Slide on Slot for 20 Gauge Panel</p>

Snap-in receptacle panel cutouts

Panel cutout 49	Panel cutout 67
<p>Panel Cutout 49 0.968" (24.6mm) 0.968" (24.6mm) Panel Thickness 0.032" - 0.070" (0.81mm - 1.78mm)</p>	<p>Panel Cutout 67 1.07" (27.2mm) 0.77" (19.6mm) Panel Thickness 0.032" - 0.070" (0.81mm - 1.78mm)</p>

Attachon lampholder cutouts

Panel cutout 732-3	Panel cutout 734	Panel cutout 4734-2
<p>1.53" (38.86mm) 1.41" (35.8mm) 0.34" (8.6mm)</p>	<p>1.38" (34.8mm) Dia. 0.188" (4.8mm) Diam. 1.8" (46.0mm)</p>	<p>1.38" (34.8mm) 2.13" (54.1mm) 0.188" (4.8mm)</p>
<p>0.90" (22.8mm) Dia. 1.03" (26.0mm) 0.425" (10.8mm)</p>	<p>0.82" (20.8mm) 0.063" (1.6mm) 0.125" (3.2mm)</p>	

Test requirements

The maximum permitted load for which a switch is suitable depends on the switch rating and the nature of the load. Proper selection of switches is determined by test standards and requirements of the National Electrical Code®, Articles 380, 430, and 600.

General Use AC switches are suitable for use at full rated current and voltage on loads of fluorescent and incandescent lighting and for other inductive or resistance loads. Our switches are rated for motor loads at 80% of their rated current.

Special Use AC switches may be used at full rating on resistance or inductive loads, including fluorescent. For incandescent (tungsten) lighting loads, they must carry an “L” rating. For motor loads they require an “HP” (horsepower) rating.

To ensure safety and reliability, Arrow Hart switches are tested, rated and marked according to various standards. The following charts indicate both the required performance tests specified by industry standards for switches with standard ratings, and the loads they may control.

Test requirements - switches general use - AC only

Rating	Standard	Overload				Endurance		Resistance cycles 1.0 pf.†	Inductive cycles .75 to .8 pf.†	Tungsten cycles 1.0 pf.†
		Amps	Volts	Power factor	Cycles	Amps	Volts (Max)			
15A, 120V/AC	UL20	72	120 AC	.4 to .5	100	15	120 AC	10,000	10,000	10,000
	WS 896	72	120 AC	.4 to .5	100	15	120 AC	-	50,000	50,000
15A 120/277 277V/AC	UL20	72	277 AC	.4 to .5	100	15	277 AC	10,000	10,000	10,000
	WS 896	72	277 AC	.4 to .5	100	15	277 AC	-	50,000	50,000
20A, 120/277 277V/AC	UL20	96	277 AC	.4 to .5	100	20	277 AC	10,000	10,000	10,000
	WS 896	96	277 AC	.4 to .5	100	20	277 AC	-	50,000	50,000
20A, 120/277 277V/AC	UL20	144	277 AC	.4 to .5	100	30	277 AC	10,000	10,000	10,000
	WS 896	144	277 AC	.4 to .5	100	30	277 AC	-	50,000	50,000

Test requirements - switches special use - AC only

Rating	Standard	Overload				Endurance				Horse power				“L” Tungsten		
		Amps	Volts	Power factor	Cycles	Amps	Volts	Power factor	Cycles	Amps	Volts	Power factor	Cycles	Amps	Volts	Cycles
8A, 120V/AC	UL1054	12	120 AC	.4-.5	50	8	120 AC	.75-.8	6000	-	-	-	-	-	-	-
15A, 120V/AC 10A, 240V/AC 3/4 HP, 120-240V/AC	UL1054	15	240 AC	.4-.5	50	10	240 AC	.75-.8	6000	82.8	120 AC	.4-.5	50	-	-	-
										41.4	240 AC	.4-.5	50	-	-	-
15A, 125-250V/AC 3/4 HP, 120-240V/AC	UL1054	22.5	250 AC	.4-.5	50	15	250 AC	.75-.8	6000	82.8	120 AC	.4-.5	50	-	-	-
										41.4	240 AC	.4-.5	50	-	-	-
20A, 125V/AC “L” 20A, 250V/AC 1 HP, 120-240V/AC	UL1054	30	240 AC	.4-.5	50	20	250 AC	.75-.8	6000	96	120 AC	.4-.5	50	20	125 AC	6000
										48	240 AC	.4-.5	50	-	-	-

WSB 896 Standard

All switches are subjected to resistive endurance, inductive endurance, tungsten endurance and then verified that they meet less than a 86°F (30°C) temperature rise at rated current and followed by a dielectric test at 1500 V/AC for 1 minute.

† Power Factor voltage,

Maximum loads

Maximum loads - switches - general use - AC only

Switch rating	Incandescent		Inductive (fluorescent)		Resistance		Motors		
	Volts	Amps	Volts	Amps	Volts	Amps	Volts	HP	Amps
15A, 120V/AC	120 AC	15	120 AC	15	120 AC	15	120 AC	1/2	12
20A, 120V/AC	120 AC	20	120 AC	20	120 AC	20	120 AC	1	16
15A, 120/277V/AC	120 AC	15	277 AC	15	277 AC	15	120 AC	1/2	12
							240 AC	1	12
20A, 120/277V/AC	120 AC	20	277 AC	20	277 AC	20	120 AC	1	16
							240 AC	2	16
30A, 120/277V/AC	120 AC	30	277 AC	30	277 AC	30	120 AC	2	24
							240 AC	2	24

Maximum loads - switches - special use - AC only

Switch rating	Incandescent		Inductive (fluorescent)		Resistance		Motors		
	Volts	Amps	Volts	Amps	Volts	Amps	V/AC	HP	Amps
8A, 120V/AC 15A, 120V/AC	Not suitable		120 AC	8	120 AC	8	Not suitable		
			120 AC	15	120 AC	15			
10A, 240V/AC 3/4HP, 120/240V/AC	Not suitable		250 AC	10	240 AC	10	240V/AC	3/4	12
15A, 120-240V/AC 3/4HP, 120/240V/AC	Not suitable		250 AC	15	250 AC	15	240V/AC	3/4	12
20A, 120V/AC "L" 20A, 250V/AC 1HP, 120/240V/AC	125 AC	20	250 AC	20	250 AC	20	240V/AC	1	12

Compliances, specifications and availability are subject to change without notice.

Chemical resistant properties of common materials in wiring devices

Key terms describing material enhancements

Thermoplastic:	Material treated for UV stability to increase tensile strength and decrease discoloration when exposed to UV radiation. Manufactured by injection molding. Superior resistance to impacts, chemical and solvent attack.
Thermoset:	Flame resistant material with dimensional stability. Manufactured by compression molding.
Glass filled:	Glass-filled material (most commonly nylon) yields increased material rigidity and permits operation at a higher temperature.
Nickel plated:	Plating of steel or brass with nickel to increase the corrosion-resistant properties of the metal component.
Zinc plated:	Plating of cold-rolled steel with zinc to increase the corrosion-resistant properties of the metal component or casing.

Materials	Acids	Alcohol	Caustic bases	Gasoline	Grease	Kerosene	Oil	Solvents	Water
Nylon (Thermoplastic)	3	1	1	1	1	1	1	1	1
Polycarbonate (Thermoplastic)	2	1	3	2	2	2	2	3	1
302/304 Stainless steel	2	1	3	1	1	1	1	2	1
Polyvinyl Chloride (PVC)	1	1	1	1	1	1	1	3	1
Polypropylene (Thermoplastic)	1	1	1	1	1	1	1	2	1
PBT	1	1	2	1	1	1	1	2	1
Rubber‡ (Thermoplastic)	2	2	1	3	2	3	1	3	1
Phenolic (Thermoset)	2	1	2	1	1	1	1	1	1
ABS (Thermoplastic)	2	2	1	1	1	2	2	3	1

Chemical resistance factor

- 1 – Completely resistant — good to excellent for general use when exposed to these factors.
- 2 – Resistance is fair to good — recommended for limited service when exposed to these factors.
- 3 – Slow attack. Not recommended for use when exposed to these factors.

*The chemical resistance factor represents general applications. Additional testing is required to determine resistance to chemicals in specific environments.

‡ Thermoplastic rubber is representative of Santoprene.

For additional material compatibility details, please contact Eaton at: TechSupport@eaton.com

Compliances, specifications and availability are subject to change without notice.

There is a greater awareness of the possibility of contamination on shared surfaces as well as high contact areas, such as wall plates, dimmers, switches, keypads and receptacles. Eaton has developed recommended guidelines for cleaning our products that will not impact the operation or finish of the product.

Eaton Recommended Cleaning Tips

1. **Never spray any fluids directly into the device**
2. **Use a damp rag or single-use wipe** to avoid excess liquid penetrating the device.
3. Be sure to wipe up remaining excess liquid after cleaning.
4. Ensure the cleaning agent used does not have harsh chemicals such as bleach, ammonia, highly alkaline or concentrated acids (such as hydrochloric acid that can be found in household cleaners such as toilet bowl cleaners, bathroom tile and porcelain cleaners) as they could damage the device, causing them to become brittle and discolored.
5. Eaton recommends the use of a mild liquid detergent and water to clean the devices. Single use wipes (e.g. Lysol brand or equivalent) are acceptable to use for cleaning the devices, however the single-use wipes cannot contain bleach, ammonia, highly alkaline or concentrated acids.



Eaton Recommended Cleaning instructions

1. **Never spray any fluids directly into the device**
2. Apply the mild liquid detergent to a damp cloth or paper towel. Single use wipes (e.g. Lysol brand or equivalent) are acceptable to use for cleaning the devices, however single-use wipes cannot contain bleach, ammonia, highly alkaline or concentrated acids.
3. If excess liquid is present, remove by wringing out the cloth or paper towel to avoid liquid penetration into the device.
4. Clean the Eaton device by wiping over the surface with the damp cloth.
5. Remove an excess liquid remaining on the device with a dry cloth or paper towel.

Additional resources for cleaning and disinfectant guidelines include:

The Center for Disease Control website (CDC.gov) provides a resource on disinfection guidelines for areas of your home or workspace. The Environmental Protection Agency (EPA.gov) site provides an up-to-date database of products that meet EPA criteria for use against COVID-19.

For more information:

Eaton's technical support center

Phone (Toll Free): 866-853-4293, option 2

NEMA enclosure ratings

Device locations

Protection from	Device locations		
	Indoors	Indoors or outdoors	Outdoors with external mechanisms
Limited amounts of falling dirt	NEMA type 1		
Limited amounts of falling dirt and dripping water	NEMA type 2		
Rain, sleet, falling dirt, windblown dust, damage from ice formation		NEMA type 3	
Rain, sleet, falling dirt, damage from ice formation		NEMA type 3R	
Rain, sleet, windblown dust, ice laden operation possible			NEMA type 3S
Windblown dust and rain, splashing water, hose-directed water, damage from ice formation		NEMA type 4	
Corrosion, windblown dust and rain, splashing water, hose-directed water, damage from ice formation		NEMA type 4X	
Falling dirt and settling airborne dust, lint, fibers and dripping non-corrosive liquids	NEMA type 5		
Hose-directed water, entry of water during occasional short-term limited depth submersion, damage from ice formation		NEMA type 6	
Hose-directed water, entry of water during long-term limited depth submersion, damage from ice formation		NEMA type 6P	
Class I, Division 1, groups A,B,C or D hazardous locations (as defined by NEC®, NFPA 70)	NEMA type 7 (commonly referred to as explosion-proof)		
Class I, Division 1, groups A,B,C or D hazardous locations (as defined by NEC®, NFPA 70)	NEMA type 8 (commonly referred to as oil-immersed)		
Class II, Division 1, groups E, F and G hazardous locations (as defined by NEC®, NFPA 70)	NEMA type 9 (commonly referred to as dust-ignition-proof)		
Meets applicable requirements of the Mine Safety & Health Administration, 30 CFR, part 18		NEMA type 10	
Circulating dust, falling dirt, dripping non-corrosive liquids	NEMA type 12 NEMA type 12K		
Dust, spraying of water, oil and non-corrosive coolant	NEMA type 13		

IP enclosure ratings

First digit - protection against persons - touching & ingress of solid objects	Second digit - protection against penetration of liquids	IP_0	IP_1	IP_2	IP_3	IP_4	IP_5	IP_6	IP_7	IP_8	IP_9K
		Non-protected	Vertical falling of water drops	Falling of water drops at angle up to 15° from vertical	Spraying water (rain) at angle up to 60° from vertical	Splashing water from any direction (360°)	Water jets from any direction (360°)	Power jetting water	Temporary immersion in water	Continuous immersion in water	High pressure. High temperature water spray from multiple directions and angles.
IP0_	Without protection	IP00									
IP1_	Touching with hand & solid objects > 50mm dia.	IP10	IP11	IP12							
IP2_	Touching with finger & solid objects > 12mm dia.	IP20	IP21	IP22	IP23						
IP3_	Touching with tools, wires, etc. > 2.5mm thick & solid objects > 2.5mm dia.	IP30	IP31	IP32	IP33	IP34					
IP4_	Touching with tools, wires, etc. > 1mm thick & solid objects > 1mm dia.	IP40	IP41	IP42	IP43	IP44					
IP5_	Unlimited protection against contact with live parts & damaging dust deposits	IP50				IP54	IP55				
IP6_	Unlimited protection against contact with live parts & any dust penetration	IP60					IP65	IP66	IP67	IP68	IP69K

Compliances, specifications and availability are subject to change without notice.

Enclosure type cross reference: NEMA/UL/CSA

NATIONAL ELECTRICAL MANUFACTURERS ASSOCIATION

NEMA Standards publication no.250-1991, enclosures for electrical equipment (1000V max.)

Intended use and description

An enclosure is a surrounding case that provides personnel with protection against incidental contact with enclosed equipment, and simultaneously protects enclosed equipment against specific environmental conditions.

Type 1

Enclosures are intended for indoor use primarily to protect against limited amounts of falling dirt.

Type 2

Enclosures provide a degree of protection, mainly indoors, against limited amounts of dripping water or falling dirt.

Type 3

Enclosures, intended primarily for use outdoors, protect against rain, sleet, wind-blown dust, and damage from external ice formation.

Type 3R

Enclosures provide protection primarily against rain, sleet, and damage from external ice formation.

Type 3S

Enclosures protect primarily against rain, sleet, and wind-blown dust, and enable external mechanisms to operate efficiently even when ice laden.

Type 4

Enclosures provide protection, both indoors and out, against wind-blown dust and rain, splashing or hose-directed water, and ice damage.

Type 4X

Enclosures used both indoors and out to protect against corrosion, wind-blown dust and rain, splashing or hose-directed water, and damage caused by exterior ice formation.

Type 5

Enclosures used primarily indoors to provide protection against airborne dust and dirt, and non-corrosive liquids.

Type 6

Enclosures provide protection both indoors and out against hose-directed water, water entry during occasional short-term submersion at low-pressure depths, and damage caused by exterior ice formation.

Type 6P

Enclosures protect both indoors and out against hose-directed water, water entry during long-term submersion at low-pressure depths, and ice damage.

Type 12

Enclosures used primarily indoors to protect against airborne dust or dirt, and non-corrosive liquids.

Type 12K

Enclosures with knockouts are used primarily indoors for protection against airborne dust and dirt, and non-corrosive liquids.

Type 13

Enclosures used primarily indoors to protect against dust, as well as accidental spraying by water, oil, or non-corrosive coolants.

UNDERWRITERS LABORATORIES UL50

Standard for enclosures for electrical equipment (10th Edition)

Intended use and description

An enclosure is a surrounding case that protects equipment enclosed within against incidental contact, as well as specific environmental conditions. A complete enclosure shall be provided for all live parts that may be housed in it. Such an enclosure shall be tight and come with a means for mounting, unless it's designed for a special installation, for example, a cast metal junction or pull-box intended for installation in poured concrete.

Type 1

Enclosures are intended for indoor use primarily to protect against limited amounts of falling dirt.

Type 2

Enclosures provide a degree of protection, mainly indoors, against limited amounts of dripping water or falling dirt.

Type 3

Enclosures, intended primarily for use outdoors, protect against rain, sleet, wind-blown dust, and damage from external ice formation.

Type 3R

Used primarily outdoors for protection against rain, sleet, and exterior damage caused by the formation of ice.

Type 3S

Used primarily outdoors for protection against rain, sleet, and wind-blown dust, and to enable exterior mechanisms to operate when ice laden.

Type 4

For indoor and outdoor use to protect against wind-blown dust and rain, splashing or hose-directed water, and damage caused by exterior ice formation.

Type 4X

For protection indoors and out from corrosion, wind-blown dust and rain, splashing or hose-directed water, and damage caused by exterior ice formation.

Compliances, specifications and availability are subject to change without notice.



USMCA compliant products meet specifications at time of print. Product listing subject to change.

For specific product details visit www.eaton.com/wiringdevices or email TechSupport@eaton.com



Buy American Provision, American Recovery and Reinvestment Act (ARRA) (Section 1605)

ARRA Section 1605 establishes requirements for federal government projects funded with stimulus monies: "None of the funds appropriated or otherwise made available by [the ARRA] may be used for a project for the construction, alteration, maintenance, or repair of a public building or public work unless all of the iron, steel, and manufactured goods used in the project are produced in the United States." Iron and steel used as components or subcomponents of other manufactured construction materials do not need to be produced in the United States. There is no requirement that components and subcomponents be U.S.-origin provided the manufactured construction material is "produced in the United States." (FAR 25.001(c)(4)) Section 1605 does not contain a domestic cost requirement. However, the government has not defined "produced" for purposes of the ARRA Buy American provision. Many commentators have adopted the "substantial transformation" test to determine whether a manufactured article is "produced" in the United States for purposes of Section 1605. Section 1605 contains a requirement that the Buy American provision be applied in a manner consistent with U.S. obligations under international agreements. As a result, national treatment is extended to products from countries with which the United States has entered a free trade agreement (e.g., Canada, Mexico, Bahrain, Chile, etc.) and to products from countries that have signed the WTO Government Procurement Agreement. National treatment is also extended to least developed countries (LDCs) (e.g., Bhutan, Mali, Zambia, etc.) but not to Caribbean basin countries (e.g., Belize, Haiti, Bahamas, etc.). Products that are identified as USMCA compliant may qualify under the Buy American Act or ARRA program guidelines. Consult specific project guidelines and compliance requirements to assure suitability for your project needs.

Buy American Act (US Code, Title 41, Section 10 (a-d))

The Buy American Act (often BAA, not to be confused with the Buy America (no "n") Act) applies to all U.S. federal government agency purchases of goods over certain contract thresholds. The BAA restricts purchases of supplies and construction materials to domestic products, unless an exception or waiver applies. Unmanufactured products must be mined or produced in the United States. There is a two-part test for manufactured articles: (1) article must be manufactured in the United States, and (2) cost of U.S. components must exceed 55% of the cost of all components in the item. Note: this calculation does not include labor and overhead for final assembly in the United States. The component cost test is waived for commercial-off-the-shelf (COTS) items. (FAR 25.001(c)(1)). BAA waivers may be available, often at the discretion of the contracting officer.



Restriction of the use of certain hazardous substances (RoHS)

For more information visit eaton.com/us/en-us/products/productstewardship or email ProductStewardship-ES@Eaton.com

Compliances, specifications and availability are subject to change without notice.